



TRIMMING BLADE SERIES

COMET	2 / 4
EASTMAN	2 / 4 / 6
HITAKA	2 / 4
KM	2 / 4 / 6
KURIS	3
LIGHTING	3
MAIMIN	3 / 5 / 6
WOLF	3 / 5



© Great Knives Manufacture Co., Ltd.

The trademark and artworks are the intellectual property which is preserved by
GREAT KNIVES MANUFACTURE Co., Ltd. All offense against
 the copyright will be sued by the owner.

FOR COMET



5C	High Speed Steel
6C	
7C	Super Alloy Steel
8C	
9C	Alloy Steel
10C	
11C	
12C	

FOR EASTMAN



4E	High Speed Steel
5E	
6E	Super Alloy Steel
7E	
8E	Alloy Steel
9E	
10E	
11 1/2E	
13E	
15E	



4ET	High Speed Steel
5ET	
6ET	Super Alloy Steel
7ET	
8ET	Alloy Steel
9ET	
10ET	
11 1/2ET	
13ET	

FOR HITAKA



4H	High Speed Steel
5H	
6H	Super Alloy Steel
7H	
8H	Alloy Steel
9H	
10H	

FOR KM.



4KM(N)	High Speed Steel
5KM(N)	
6KM(N)	Super Alloy Steel
6KM	
7KM	Alloy Steel
8KM	
9KM	
10KM	



© Great Knives Manufacture Co., Ltd.

The trademark and artworks are the intellectual property which is preserved by GREAT KNIVES MANUFACTURE Co., Ltd. All offense against the copyright will be sued by the owner.

FOR KURIS

6K
7K
8K
10K

High Speed Steel

FOR LIGHTNING

6L
8L
10L
12L
14L

High Speed Steel

Super Alloy Steel

Alloy Steel

FOR MAIMIN

4M
5M
6M
7M
8M
9M
10M
11M
14M

High Speed Steel

Super Alloy Steel

Alloy Steel

FOR WOLF

4W
5W
6W
7W
8M
9M
10M
14W

High Speed Steel

Super Alloy Steel

Alloy Steel



© Great Knives Manufacture Co., Ltd.

The trademark and artworks are the intellectual property which is preserved by GREAT KNIVES MANUFACTURE Co., Ltd. All offense against the copyright will be sued by the owner.

FOR COMET



6CW
7CW
8CW
9CW
10CW

High Speed Steel

FOR EASTMAN



6EW
7EW
8EW
9EW
10EW

High Speed Steel

Super Alloy Steel

Alloy Steel



5EWT
6EWT
7EWT
8EWT
9EWT
10EWT

High Speed Steel

Super Alloy Steel

Alloy Steel

FOR HITAKA



5HW
6HW
7HW
8HW
9HW
10HW

High Speed Steel

Super Alloy Steel

Alloy Steel

FOR KM.



5KMW
6KMW
7KMW
8KMW
9KMW
10KMW

High Speed Steel

Super Alloy Steel

Alloy Steel



© Great Knives Manufacture Co., Ltd.

The trademark and artworks are the intellectual property which is preserved by GREAT KNIVES MANUFACTURE Co., Ltd. All offense against the copyright will be sued by the owner.

FOR MAIMIN



6MW	High Speed Steel
7MW	High Speed Steel
8MW	Super Alloy Steel
9MW	Super Alloy Steel
10MW	Alloy Steel

FOR WOLF



6WW	High Speed Steel
7WW	High Speed Steel
8WW	Super Alloy Steel
9WW	Super Alloy Steel
10WW	Alloy Steel



© Great Knives Manufacture Co., Ltd.

The trademark and artworks are the intellectual property which is preserved by GREAT KNIVES MANUFACTURE Co., Ltd. All offense against the copyright will be sued by the owner.

FOR EASTMAN



High Speed Steel

- 643C1-41(6in)
- 643C1-42(7in)
- 643C1-43(8in)
- 643C1-46(9in)
- 643C1-47(10in)
- 643C1-53(11-1/2in)
- 643C1-45(13in)

FOR KM.



High Speed Steel

- 5KM-SLIDER-HSS
- 6KM-SLIDER-HSS
- 8KM-SLIDER-HSS
- 10KM-SLIDER-HSS

FOR MAIMIN



High Speed Steel

- 6M-SLIDER-HSS
- 8M-SLIDER-HSS
- 9M-SLIDER-HSS
- 10M-SLIDER-HSS
- 11M-SLIDER-HSS



© Great Knives Manufacture Co., Ltd.

The trademark and artworks are the intellectual property which is preserved by GREAT KNIVES MANUFACTURE Co., Ltd. All offense against the copyright will be sued by the owner.



ROUND KNIFE SERIES

BEAVER	8
EASTMAN	8
HITAKA	9
HOOG'S	9
KM	9
KURIS	10
MAIMIN	11
SUPERNA	12
WOLF	13
LOWER KNIVES	10
OTHERS	11



© Great Knives Manufacture Co., Ltd.

The trademark and artworks are the intellectual property which is preserved by GREAT KNIVES MANUFACTURE Co., Ltd. All offense against the copyright will be sued by the owner.

FOR BEAVER



R2-5/16B(10)

59 x 10.0 x 1.00



R 5 1/4B
R 5 1/4B55

133 x 50.8 x 1.20



R 6B

152 x 50.8 x 1.20

FOR EASTMAN



123-HSS
80C1-123

51 x 16.2 x 1.05



147-HSS
80C1-147

57 x 16.0 x 1.10



149-HSS
80C1-149

57 x 16.0 x 1.05



114-HSS
80C1-114

64 x 22.4 x 1.00



133-HSS
80C1-133

51 x 16.0 x 1.20



R 4E#141
80C1-141

102 x 22.2 x 1.00



R 4E
80C1-59

102 x 41.0 x 1.05



R 5 1/4E
80C1-61

133 x 52.0 x 1.05



R 5E
80C1-101

127 x 39.6 x 1.10



R 6E
80C1-39

152 x 51.0 x 1.45



R 7E

178 x 51.0 x 1.50



R 7 1/2E

191 x 51.0 x 1.90



© Great Knives Manufacture Co., Ltd.

The trademark and artworks are the intellectual property which is preserved by GREAT KNIVES MANUFACTURE Co., Ltd. All offense against the copyright will be sued by the owner.

FOR HITAKA



R 2 1/2H

63 x 12.2 x 0.80



**RE-12
RE-12-HSS**

66 x 10.0 x 1.00



R 3 1/2H

89 x 17.5 x 0.90



R 5H

127 x 40.0 x 1.10

FOR HOOGS



**MS-55(7)
115-90/1-MS-55**

47 x 10.0 x 1.00



**HOOG'S(R)
501-140/1-MS21**

110 x 10.0 x 1.20



**HOOG'S 110_{m/m}
R110-90/3-MS-2**

110 x 10.0 x 1.60

FOR KM



**R 2KM
A-113(R)
RS-50**

50 x 10.0 x 1.25



**R 2KM(7)
A-113
RS-50(7)**

48 x 10.0 x 1.05



**R 2KM(7)-HSS
A-113-HSS
RS-50(7)-HSS**

48 x 10.0 x 1.05



**R 4KM
RS-100**

100 x 21.0 x 1.20



**R 4KM(8)
RCS-135(8)
RS-100(8)**

100 x 21.0 x 1.20



R 5KM-HSS

127 x 43.0 x 1.20



R 6KM-HSS

152 x 50.0 x 1.50



© Great Knives Manufacture Co., Ltd.

The trademark and artworks are the intellectual property which is preserved by GREAT KNIVES MANUFACTURE Co., Ltd. All offense against the copyright will be sued by the owner.

FOR KURIS



16110(6)
24741(6)
2(6)KURIS

50 x 16.0 x 1.00



16120(8)
R 2(8)KURIS

50 x 16.0 x 1.00



R 2(R)KURIS

50 x 16.0 x 1.00



16010(4)
BOM-80(4)

80 x 22.0 x 1.00



16092(6)
46377(6)
BOM-80(6)

80 x 22.0 x 1.00



15710
47014
KRH-10

120 x 35.0 x 1.20



16022(4)
24739(4)
BOM-100
BOM-101(4)

100 x 22.0 x 1.00



15722
KRH-12

120 x 35.0 x 1.20



16057(4)
46378(4)
KRH-12(4)

120 x 35.0 x 1.50



15730
KRH-15

150 x 35.0 x 1.50



15740
KRH-20

200 x 40.0 x 2.20

FOR LOWER KNIFE FOR ROUND KNIFE



R4 1/4-CT (2)

Lower Knife



R4 1/4-CT (2-2)

Lower Knife



R4 1/4-CT

Lower Knife



A-114
RS-50-CT

Lower Knife



© Great Knives Manufacture Co., Ltd.

The trademark and artworks are the intellectual property which is preserved by GREAT KNIVES MANUFACTURE Co., Ltd. All offense against the copyright will be sued by the owner.

FOR LOWER KNIFE FOR ROUND KNIFE



ACE (Upper)
08-282
471
Strip Cutter



ACE (Lower)
08-281
470
Strip Cutter

FOR MAIMIN



RS-232
50 x 16.0 x 1.05



R 2 1/2M
64 x 21.4 x 0.90



R 4M
102 x 40.0 x 1.05



R 5M
127 x 40.0 x 1.20



R 5 1/4M
R 5 1/4M59
133 x 52.0 x 1.10



R 6M
152 x 58.0 x 1.50



R 7M
178 x 58.0 x 1.50

FOR OTHERS



47410
R 28X0.3
28 x 5.0 x 0.30



47409
R 45X0.3
45 x 8.1 x 0.30



AS 1026
48 x 13.0 x 1.00



D100
100 x 22.2 x 1.05



© Great Knives Manufacture Co., Ltd.

The trademark and artworks are the intellectual property which is preserved by GREAT KNIVES MANUFACTURE Co., Ltd. All offense against the copyright will be sued by the owner.

FOR OTHERS



CH141

102 x 8.0 x 1.30



R41/4-SKS2

108 x 10.0 x 1.20



R 80x40x1.0

80 x 40.0 x 1.00



R 4 1/4

108 x 10.0 x 1.20

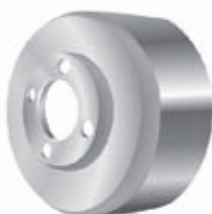

LEATHER-GE
LEATHER-SKS7
201K

117 x 114.0 x 52.20

FOR SUPRENA



M700(6)

50 x 16.0 x 1.00



M702

50 x 16.0 x 1.00



M703(8)

50 x 16.0 x 1.00



M740(8)

80 x 22.0 x 1.00



M741(6)

80 x 22.0 x 1.00



M742

80 x 22.0 x 1.00



R 1512

100 x 22.0 x 1.00



R 1513

100 x 22.0 x 1.00



R 1514

100 x 22.0 x 1.00



R 1515

100 x 22.0 x 1.00



© Great Knives Manufacture Co., Ltd.

The trademark and artworks are the intellectual property which is preserved by GREAT KNIVES MANUFACTURE Co., Ltd. All offense against the copyright will be sued by the owner.

FOR WOLF



1426371
R 2W
PUP

53 x 17.5 x 1.01



1437070
R 2 1/2W

63 x 20.5 x 0.89



1430770
R 4W

102 x 31.8 x 1.04



1430370
R 4 3/4W#22

121 x 42.8 x 1.10



1431170
R 5 1/4W#24

133 x 50.8 x 1.04



1429970
R 5 1/4W#21

133 x 42.8 x 1.00



1426970
R 6W NO.16

152 x 40.1 x 1.30



R 6W NO.18

152 x 50.8 x 1.30

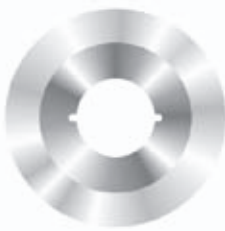

R 7W

178 x 50.8 x 1.40



R 8W

203 x 50.8 x 1.40



R 10W

254 x 50.8 x 1.60



© Great Knives Manufacture Co., Ltd.

The trademark and artworks are the intellectual property which is preserved by GREAT KNIVES MANUFACTURE Co., Ltd. All offense against the copyright will be sued by the owner.



OVERLOCK KNIFE SERIES



BABYLOCK	15	REECE	23
BROTHER	16	SIRUBA	23
DAIKOKU	16	SINGER	24
JUKI	16	TOYOTA	24
KANSAI-SP	18	UNION-SP	25
MERROW	19	YAMATO	25
NEW HOME	19	OTHERS	28
NEW LONG	19		
PEGASUS	20		
RIMOLDI	21		





© Great Knives Manufacture Co., Ltd.





The trademark and artworks are the intellectual property which is preserved by GREAT KNIVES MANUFACTURE Co., Ltd. All offense against the copyright will be sued by the owner.

FOR BABYLOCK ←←←

				
60544	205-9102-01A	408-9102-01A	205-9101-01A	408-9101-01B
Lower	Lower (CT)	Upper	Upper	Upper

FOR BROTHER ←←←

				
428-9101-01B	PL-Q1-01B	60507	405-9101-01A	112436-0-01 155193-0-01
Upper	Upper	Upper (CT)	Upper (CT)	Lower

				
118527-0-01	S20582-001	S20899-001	S20583-001	X05007001
Lower	Lower	Lower	Lower	Lower



© Great Knives Manufacture Co., Ltd.

The trademark and artworks are the intellectual property which is preserved by GREAT KNIVES MANUFACTURE Co., Ltd. All offense against the copyright will be sued by the owner.

FOR BROTHER



148198-0-01

Upper



127734001

Upper



144074-0-01

Upper (CT)



144074-300

Upper (CT)



140242-0-01

Angled Upper (CT)



S20579-101

Angled Upper (CT)



S20898-101

Angled Upper (CT)



S20897-101

Angled Upper (CT)



S20896-101

Angled Upper (CT)



148815-0-01

Angled Upper (CT)

FOR DAIKOKU



DSK-25

Lower



DSK-27

Upper



B4118-804-000
B4118-804-00C

Lower



B4122-352-00A
B4122-352-000
B4122-354-00A
B4122-357-00D

Lower



118-46003















Lower

FOR JUKI



© Great Knives Manufacture Co., Ltd.

The trademark and artworks are the intellectual property which is preserved by GREAT KNIVES MANUFACTURE Co., Ltd. All offense against the copyright will be sued by the owner.

FOR JUKI				
				
115-66502 Lower	124-47504 Lower	A4113-102-000 A4145-335-000 Lower	MAS-11016000 Lower	MAS-11017000 Lower
				
B4108-352-00B(L) Upper	611325N Upper	118-47506 Upper	164-16109 Upper	164-18709 Upper
				
MAS-11012000 Upper	MAS-11013000 Upper	A4142-335-000 Upper (CT)	B4108-352-00B B4108-352-000 Upper	118-47407 Upper



© Great Knives Manufacture Co., Ltd.

The trademark and artworks are the intellectual property which is preserved by GREAT KNIVES MANUFACTURE Co., Ltd. All offense against the copyright will be sued by the owner.

FOR JUKI



118-45708

Upper (CT)



120-04909

Upper(CT)



118-45609

Upper (CT)



B4108-352-00D

Upper (CT)



B4111-804-00C

Angled Upper

FOR KANSAI-SP



118-45906

Angled Upper (CT)



118-45807

Angled Upper (CT)



B4111-804-00A

Angled Upper (CT)



115-65900

Angled Upper(CT)



07-169

Lower



07-206

Lower



07-507

Lower



07-558

Lower



07-707

Lower



07-168
07-170

Upper



© Great Knives Manufacture Co.,Ltd.

The trademark and artworks are the intellectual property which is preserved by GREAT KNIVES MANUFACTURE Co., Ltd. All offense against the copyright will be sued by the owner.

FOR KANSAI-SP



07-505

Upper



07-570

Upper



07-703

Upper (CT)



07-702

Angled Upper (CT)



07-124

Angled Upper (CT)

FOR MERROW

FOR NEW HOME



07-406

Angled Upper (CT)



6-91E

Lower



6-91

Lower



6-90

Upper



113
ML-113

Lower

FOR NEW LONG



784048
784048001

Lower (CT)



110-1
ML-110-1

Upper



784045
784045008

Upper (CT)



246061

Moving



246071



















Fixed



© Great Knives Manufacture Co., Ltd.

The trademark and artworks are the intellectual property which is preserved by GREAT KNIVES MANUFACTURE Co., Ltd. All offense against the copyright will be sued by the owner.

FOR PEGASUS

							
202573 201127 323-870-203 323-870-211	202572 202295 323-870-202 323-870-210	137562	277009	204161 323-870-213	204161A		
Lower	Lower	Lower	Lower	Lower	Lower	Lower	Lower
							
3543 312-870-001	202893 323-870-212 323-870-215	204351 323-870-218	138559	202570 323-870-200			
Lower	Lower (CT)	Lower (CT)	Upper	Upper			
							
3544A 312-870-003	277000	200971	205890	202527 323-870-207 323-870-005	202527A		
Upper	Upper	Upper (CT)	Upper (CT)	Upper (CT)	Upper (CT)		



© Great Knives Manufacture Co., Ltd.

The trademark and artworks are the intellectual property which is preserved by GREAT KNIVES MANUFACTURE Co., Ltd. All offense against the copyright will be sued by the owner.

FOR PEGASUS



201121ANS

Upper (CT)



201121A
323-870-214

Upper (CT)



205258

Upper (CT)



306394

Upper (CT)



210755(CT)

Angled Upper

FOR RIMOLDI



270-113

Lower



270-113/1
202146-0-10

Lower



2701P9-113/1
203144-0-10

Lower



277-113
203012-0-10

Lower



279-113/1
203069-0-10

Lower



6378-113
302808-0-10

Lower



290-113
204693-0-10

Lower



290-113SP
204693-0-11

Lower



CT270-113/1
207015-2-00

Lower (CT)



CT277-113
207016-2-00

Lower (CT)



© Great Knives Manufacture Co., Ltd.

The trademark and artworks are the intellectual property which is preserved by GREAT KNIVES MANUFACTURE Co., Ltd. All offense against the copyright will be sued by the owner.

FOR RIMOLDI



CT279-113/1
207017-2-00

Lower (CT)



CT290-113
207020-2-00
207020-2-01

Lower (CT)



CT290-113SP

Lower (CT)



302807-0-10
6378-112

Upper



CT302865-0-11

Upper (CT)



270-112
202142-0-10

Angled Upper



270-112/1
202143-0-10

Angled Upper



279-112
203066-0-10

Angled Upper



2768-112
202932-0-10

Angled Upper



277-112
203010-0-10

Angled Upper



2777-112
203759-0-10

Angled Upper



290-112
2777-1121
203783-0-10

Angled Upper



CT270-112
207000-200

Angled Upper (CT)



CT279-112
207006-2-00

Angled Upper (CT)

















CT290-112
CT2777-1121
207003-2-00

Angled Upper (CT)



© Great Knives Manufacture Co., Ltd.

The trademark and artworks are the intellectual property which is preserved by GREAT KNIVES MANUFACTURE Co., Ltd. All offense against the copyright will be sued by the owner.

FOR RIMOLDI			FOR REECE	
				
CT276B-112 207001-2-00	CT277-112 207002-2-00	CT2777-112 207004-2-00	32-2047-1-001	32-2047-1-002
Angled Upper (CT)	Angled Upper (CT)	Angled Upper (CT)	Left	Right
			FOR SIRUBA	
				
32-2048-1-001	32-2048-1-002	48-1125-5-721	B KR-35	KR-35C
Left	Right	Top	Lower	Lower
				
KR-23C	KR-23	KR-23A	42309	164728 164233
Upper (CT)	Upper (CT)	Upper (CT)	Lower	Lower



© Great Knives Manufacture Co., Ltd.

The trademark and artworks are the intellectual property which is preserved by GREAT KNIVES MANUFACTURE Co., Ltd. All offense against the copyright will be sued by the owner.

FOR SINGER



164037

Lower



410295

Lower



412749

Lower



CT164728
164813

Lower (CT)



42305

Upper



164809

Upper (CT)



412585
412544

Upper (CT)



164308

Angled Upper



164550

Angled Upper



164556

Angled Upper

FOR TOYOTA



1250004-237B

Lower



1250004-229B

Upper



1650004-229

Upper (CT)



1270004-229

Upper (CT)



1250014-229





Upper (CT)







© Great Knives Manufacture Co., Ltd.





The trademark and artworks are the intellectual property which is preserved by GREAT KNIVES MANUFACTURE Co., Ltd. All offense against the copyright will be sued by the owner.

FOR UNION-SP <<<

				
39549	28964	39549J	CT39549 39549N	CT39549J
Lower	Lower	Lower	Lower (CT)	Lower (CT)

				
36270	39270A	36250	39570	39570K
Upper	Upper	Upper	Angled Upper	Angled Upper

FOR YAMATO <<<















				
39570J	CT39570J	CT39570	95277	30421
Angled Upper	Angled Upper (CT)	Angled Upper (CT)	Lower	Lower



© Great Knives Manufacture Co., Ltd.

The trademark and artworks are the intellectual property which is preserved by GREAT KNIVES MANUFACTURE Co., Ltd. All offense against the copyright will be sued by the owner.

FOR YAMATO

				
37538	22195	3101633	35285	2100167
Lower	Lower	Lower	Lower	Lower
				
3201062	3101026	3110038	37469-HSS	37472
Lower	Lower	Lower	Lower	Lower
				
2121111	95276	37469	37514	20493
Lower	Lower (CT)	Upper	Upper	Upper



© Great Knives Manufacture Co., Ltd.

The trademark and artworks are the intellectual property which is preserved by GREAT KNIVES MANUFACTURE Co., Ltd. All offense against the copyright will be sued by the owner.

FOR YAMATO



37472-HSS

Upper



20496

Upper (CT)



32914

Upper (CT)



3110037

Upper (CT)



3101028

Upper (CT)

FOR OTHERS



3101465

Upper (CT)



20491

Angled Upper (CT)



35286

Angled Upper (CT)



755128

Lower



X05007001

Lower



300417

Lower (CT)



11442

Lower (CT)



755106

Upper



127734001

Upper



330404

Upper (CT)



© Great Knives Manufacture Co., Ltd.

The trademark and artworks are the intellectual property which is preserved by GREAT KNIVES MANUFACTURE Co., Ltd. All offense against the copyright will be sued by the owner.

FOR OTHERS



0246002553

Top



21-5602

Top



B4121-052-A00

Counter Knife



B4121-522-000

Counter Knife



© Great Knives Manufacture Co., Ltd.

The trademark and artworks are the intellectual property which is preserved by GREAT KNIVES MANUFACTURE Co., Ltd. All offense against the copyright will be sued by the owner.



TRIMMING BLADE SERIES

ADLER	30
BROTHER	30
JUKI	32
MERROW	34
MITSUBISHI	34
PEGASUS	35
PFAFF	35
REECE	35
RIMOLDI	35
SINGER	36
SIRUBA	36
TAJMA	36
UNION-SP	36
YAMATO	36



© Great Knives Manufacture Co., Ltd.

The trademark and artworks are the intellectual property which is preserved by
GREAT KNIVES MANUFACTURE Co., Ltd. All offense against
 the copyright will be sued by the owner.

FOR ADLER	FOR BROTHER		
			
129-17-185-3 Counter Knife	105306-101 Thread Cutter	105307-101 Thread Cutter	140888-001 Thread Cutter
			
152906-0-01 Thread Retainer	THREAD-260 Thread Cutter	THREAD-755 Thread Cutter	141509-001 Upper Thread
			
141512-001 Upper Thread	141513-001 Upper Thread	152905-0-01 Fixed Knife	S10210-001 Fixed Knife
			
SO3627-001 Fixed Knife	S56917-001 Fixed Knife	141543-0-01 Fixed Knife	SO2637-001 Fixed Knife



© Great Knives Manufacture Co., Ltd.

The trademark and artworks are the intellectual property which is preserved by GREAT KNIVES MANUFACTURE Co., Ltd. All offense against the copyright will be sued by the owner.

FOR BROTHER			
			
153020-001 Fixed Knife	S07527-001 Fixed Knife	S02645-001 Moving Knife	152901-0-01 Moving Knife
			
S07526-001 Moving Knife	S56370-001 Moving Knife	S03629-001 Moving Knife	S10205-001 Moving Knife
			
S37723-001 Moving Knife	141541-0-01 Moving Knife	141541-0-02 Moving Knife	S20118-001 Trimming Knife
			
152981-0-01 Knife Arm	152897-0-01 Knife Connection Rod	S16248-001 Top Knife	



© Great Knives Manufacture Co., Ltd.

The trademark and artworks are the intellectual property which is preserved by GREAT KNIVES MANUFACTURE Co., Ltd. All offense against the copyright will be sued by the owner.

FOR JUKI			
			
102-11100 Moving Knife	102-11605 Moving Knife	114-09257 Moving Knife	B2421-205-OAO Moving Knife
			
B2421-210-OOO Moving Knife	B2421-210-AAO Moving Knife	B2421-280-000 B2421-280-OAO Moving Knife	B2406-373-OAO Moving Knife
			
D2402-555-BAO Moving Knife	110-40052 Moving Knife	B2406-761-OAO Bobbin Thread Trimmer Blade	B2406-771-OAO Bobbin Thread Trimmer Blade
			
B2410-373-000 Fixed Knife	B2424-280-000 Fixed Knife	102-11209 Fixed Knife	114-09604 Fixed Knife



© Great Knives Manufacture Co., Ltd.

The trademark and artworks are the intellectual property which is preserved by GREAT KNIVES MANUFACTURE Co., Ltd. All offense against the copyright will be sued by the owner.

FOR JUKI



226-55302

Fixed Knife



B2424-210-000

Fixed Knife



B2424-210-AOO

Fixed Knife



D2406-555-B00
D2406-555-D0H

Fixed Knife



137-31161

Needle Thread

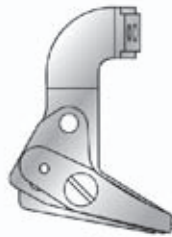

B2001-761-OAO

Needle Thread



B2001-762-OAO

Needle Thread



B2001-771-OAO

Needle Thread



B2003-761-000

Needle Thread



B2003-771-000

Needle Thread



B2408-761-000

Counter Knife



B2408-771-000

Counter Knife



B1530-352-000

Thread Trimmer



B1528-804-000
B1528-804-000A

Chain Cutter Knife



137-36103

Tension Spring



137-35451

Trimmer, Lower



© Great Knives Manufacture Co., Ltd.

The trademark and artworks are the intellectual property which is preserved by GREAT KNIVES MANUFACTURE Co., Ltd. All offense against the copyright will be sued by the owner.

FOR JUKI



137-35956

Trimmer, Upper



166-07301

Corner



166-07400

Corner



166-07509

Corner



166-07608

Corner



166-07707

Corner



166-07806

Corner



B2002-761-OAO

Upper Thread

FOR MERROW



B2002-771-OAO

Upper Thread



A-121-1

Thread Catcher

FOR MITSUBISHI



MF40A1834

Left Knife



MF40A2835
MF40A1835

Right Knife



MF-00A0838

Fixed Knife

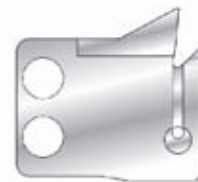

MF-02A0834

Moving Knife



© Great Knives Manufacture Co., Ltd.

The trademark and artworks are the intellectual property which is preserved by GREAT KNIVES MANUFACTURE Co., Ltd. All offense against the copyright will be sued by the owner.

FOR PEGASUS			
			
201308P 323-873-001 Chain Cutter Knife	202451 323-873-200 Chain Cutter Knife	257573 Upper	257573A Upper
			
257574 Upper	350218 Moving Knife	350220 Fixed Knife	
FOR PFAFF	FOR REECE	FOR RIMOLDE	
			
91-171853-05 Counter Knife	40-0127-1-000 40-0127-2-000 Tab Knife	42-0012-0-045 40-0012-1-045 40-0012-2-045 Center Knife	270-188 202194-0-10 Thread Cutter Knife
FOR SINGER			
			
164861 Chain Cutter Knife	55459 Shuttle Thread	414029 Stationary	540760 Stationary



© Great Knives Manufacture Co., Ltd.

The trademark and artworks are the intellectual property which is preserved by GREAT KNIVES MANUFACTURE Co., Ltd. All offense against the copyright will be sued by the owner.

FOR SINGER



414030

Underbed Trimmer



540741

Underbed Trimmer

FOR SIRUBA



KS-24

Chain Cutter Knife



BK-10F

Fixed Knife

FOR 田岛



FX0227000000

Moving Knife



AT0204000000

Moving Knife

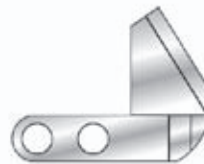

EG0204000000

Fixed Knife



FX0228000000

Fixed Knife

FOR UNION-SP



35796B

Upper Chain



35796C

Lower Chain

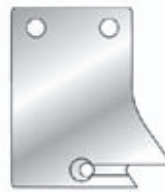

115421010

Moving knife



3100512

Fixed Knife



3100513

Moving Knife



20271

Chain Cutter



68121

Lower



68184

Upper

FOR YAMATO



© Great Knives Manufacture Co., Ltd.

The trademark and artworks are the intellectual property which is preserved by GREAT KNIVES MANUFACTURE Co., Ltd. All offense against the copyright will be sued by the owner.



BOTTON HOLE KNIFE SERIES

BROTHER	38
JUKI	38
SINGER	38
PFAFF	39
REECE	40



© Great Knives Manufacture Co., Ltd.

The trademark and artworks are the intellectual property which is preserved by GREAT KNIVES MANUFACTURE Co., Ltd. All offense against the copyright will be sued by the owner.

FOR 71 CLASS BROTHER · JUKI · SINGER



1/4"

Button Hole Knife



5/16"

Button Hole Knife



3/8"

Button Hole Knife



7/16"

Button Hole Knife



1/2"

Button Hole Knife



9/16"

Button Hole Knife



5/8"

Button Hole Knife



11/16"

Button Hole Knife



3/4"

Button Hole Knife



7/8"

Button Hole Knife



1"

Button Hole Knife



1 1/8"

Button Hole Knife



1 1/4"

Button Hole Knife



1 3/8"

Button Hole Knife



© Great Knives Manufacture Co., Ltd.

The trademark and artworks are the intellectual property which is preserved by GREAT KNIVES MANUFACTURE Co., Ltd. All offense against the copyright will be sued by the owner.

FOR 71-90 CLASS BROTHER · JUKI · SINGER



1/2"

Button Hole Knife



9/16"

Button Hole Knife



5/8"

Button Hole Knife



3/4"

Button Hole Knife



7/8"

Button Hole Knife



1"

Button Hole Knife



3/8"

Button Hole Knife



7/16"

Button Hole Knife

FOR PFAFF



020241-04/004 12.7

Button Hole Knife



020241-04/005 14

Button Hole Knife



020241-04/006 16

Button Hole Knife



020241-04/007 17.5

Button Hole Knife



020241-04/008 19

Button Hole Knife



020241-04/009 22.2

Button Hole Knife



020241-04/010 25.4

Button Hole Knife



© Great Knives Manufacture Co., Ltd.

The trademark and artworks are the intellectual property which is preserved by GREAT KNIVES MANUFACTURE Co., Ltd. All offense against the copyright will be sued by the owner.

FOR S356N 利是



1/8"

Button Hole Knife



1/4"

Button Hole Knife



5/16"

Button Hole Knife



3/8"

Button Hole Knife



7/16"

Button Hole Knife



1/2"

Button Hole Knife



7/8"

Button Hole Knife



5/8"

Button Hole Knife



11/16"

Button Hole Knife



3/4"

Button Hole Knife



9/16"

Button Hole Knife



1"

Button Hole Knife



1 1/8"

Button Hole Knife



1 1/4"

Button Hole Knife



1 3/8"

Button Hole Knife



10-3072-0-024
10-3072-1-024
C72 1 1/4RJ-RE

Knife With Regular Eye



© Great Knives Manufacture Co., Ltd.

The trademark and artworks are the intellectual property which is preserved by GREAT KNIVES MANUFACTURE Co., Ltd. All offense against the copyright will be sued by the owner.



BINDER & HEMMER FEET SERIES

BINDER	42
HEMMER FEET	58



© Great Knives Manufacture Co., Ltd.

The trademark and artworks are the intellectual property which is preserved by
GREAT KNIVES MANUFACTURE Co., Ltd. All offense against
the copyright will be sued by the owner.

<<BINDER & HEMMER FEET

-41-

PARTS NO A400/S400 PLAIN HEMMER

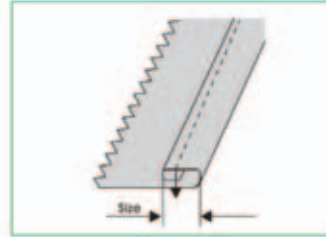

Tape Size

A400 1/16"	S400 1/16"
A400 1/2"	S400 1/2"
A400 1/4"	S400 1/4"
A400 1/8"	S400 1/8"
A400 3/16"	S400 3/16"
A400 3/8"	S400 3/8"

PARTS NO A450/S450 SPRING HEMMER

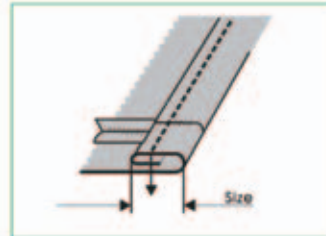

Tape Size

A450 1/16"	S450 1/16"
A450 1/4"	S450 1/4"
A450 1/8"	S450 1/8"
A450 3/16"	S450 3/16"

PARTS NO A75D/S75D SINGLE DOWNTURN HEMMER

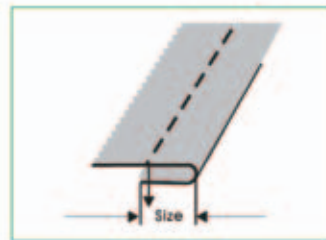

Tape Size

A75D 1/2"	S75D 1/2"
A75D 1/4"	S75D 1/4"
A75D 3/8"	S75D 3/8"



© Great Knives Manufacture Co., Ltd.

The trademark and artworks are the intellectual property which is preserved by GREAT KNIVES MANUFACTURE Co., Ltd. All offense against the copyright will be sued by the owner.

PARTS NO A75U/S75U SINGLE UPTURN HEMMER

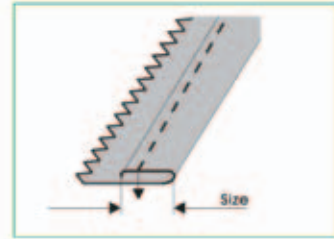

Tape Size

A75U 1/2"	S75U 1/2"
A75U 1/4"	S75U 1/4"
A75U 3/8"	S75U 3/8"

PARTS NO A4/100 HEMMERS

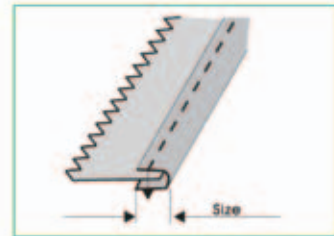

Tape Size

3/8"	3/4"
1/2"	7/8"
5/8"	1"

PARTS NO A9/508 HEMMERS

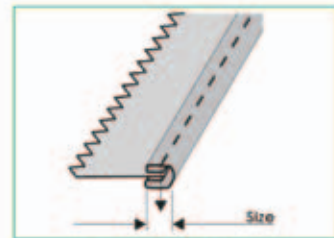

Tape Size

5/8"	1 1/2"
3/4"	1 5/8"
7/8"	1 3/4"
1"	1 7/8"
1 1/8"	2"
1 1/4"	



© Great Knives Manufacture Co., Ltd.

The trademark and artworks are the intellectual property which is preserved by GREAT KNIVES MANUFACTURE Co., Ltd. All offense against the copyright will be sued by the owner.

PARTS NO A10 / S60 RIGHT ANGLE BIAS BINDER

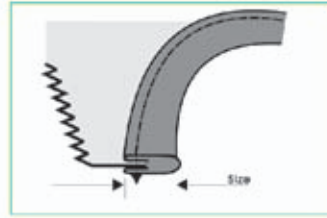

Tape Size

5/8"	16mm	1 1/4"	32mm
11/16"	18mm	1 3/8"	34mm
13/16"	20mm	1 7/16"	36mm
7/8"	22mm	1 1/2"	38mm
15/16"	24mm	1 9/16"	40mm
1"	26mm	1 3/4"	45mm
1 1/8"	28mm	2"	50mm
1 3/16"	30mm		

PARTS NO A11 / S72L HEMMERS

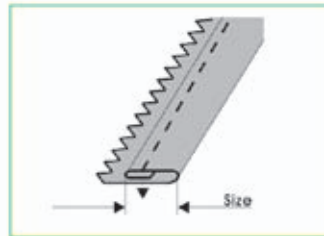

Tape Size

1/8"	3mm	13/16"	20mm
3/16"	5mm	7/8"	22mm
1/4"	6mm	1"	25mm
5/16"	8mm	1 1/8"	28mm
3/8"	10mm	1 3/16"	30mm
1/2"	13mm	1 1/4"	32mm
19/32"	15mm	1 3/8"	35mm
5/8"	16mm	1 9/16"	40mm
11/16"	18mm	1 3/4"	45mm
3/4"	19mm	2"	50mm



© Great Knives Manufacture Co., Ltd.

The trademark and artworks are the intellectual property which is preserved by GREAT KNIVES MANUFACTURE Co., Ltd. All offense against the copyright will be sued by the owner.

PARTS NO A30 / 121586 LAP SEAM FOLDERS

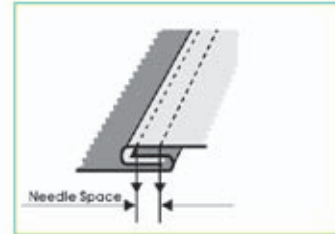

Tape Size

1/4H	3/16H
1/4M	3/16M
1/4MH	3/16MH
1/4XH	3/16XH
1/4XL	

PARTS NO A70 / S70 HEMMERS

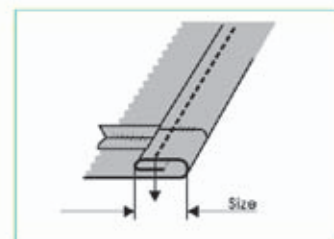

Tape Size

1/16"	1/4"
1/8"	3/8"
3/16"	1/2"



© Great Knives Manufacture Co., Ltd.

The trademark and artworks are the intellectual property which is preserved by GREAT KNIVES MANUFACTURE Co., Ltd. All offense against the copyright will be sued by the owner.

PARTS NO S123/K710NA RIGHT ANGLE BIAS BINDER

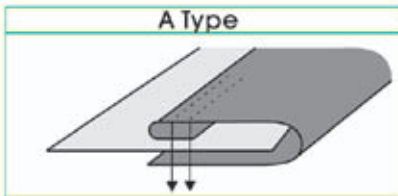

A Type

A Type

Tape Size	Finished Size
13/16"	20mm 1/4" 6mm
1"	25mm 5/16" 8mm
1 3/16"	30mm 3/8" 10mm
1 1/4"	32mm 7/16" 12mm
1 3/8"	35mm 1/2" 13mm
1 1/2"	38mm 9/16" 14mm
1 9/16"	40mm 19/32" 15mm
1 9/16"	40mm 5/8" 16mm
1 5/8"	42mm 11/16" 17mm
1 3/4"	45mm 11/16" 18mm
1 7/8"	48mm 3/4" 19mm
2"	50mm 13/16" 20mm
2 3/16"	55mm 7/8" 22mm
2 3/8"	60mm 1" 25mm
2 9/16"	65mm 1 1/8" 28mm
2 3/4"	70mm 1 3/16" 30mm
3"	75mm 1 1/4" 32mm
3"	75mm 1 5/16" 34mm

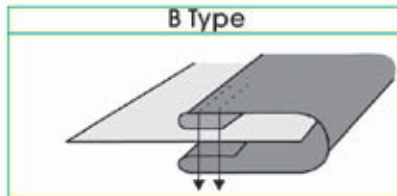

B Type

B Type

Tape Size	Finished Size
1"	25mm 1/4" 6mm
1 3/16"	30mm 5/16" 8mm
1 3/8"	35mm 3/8" 10mm
1 9/16"	40mm 7/16" 12mm
1 9/16"	40mm 1/2" 13mm
1 3/4"	45mm 9/16" 14mm
2"	50mm 5/8" 16mm
2 3/16"	55mm 11/16" 18mm
2 3/8"	60mm 13/16" 20mm
2 9/16"	65mm 7/8" 22mm
2 3/4"	70mm 1" 25mm
3"	75mm 1 1/8" 28mm
1 3/16"	80mm 1 3/16" 30mm
3 3/8"	85mm 1 5/10" 34mm



© Great Knives Manufacture Co., Ltd.

The trademark and artworks are the intellectual property which is preserved by GREAT KNIVES MANUFACTURE Co., Ltd. All offense against the copyright will be sued by the owner.

PARTS NO S124 / K712NA RIGHT ANGLE BIAS BINDER

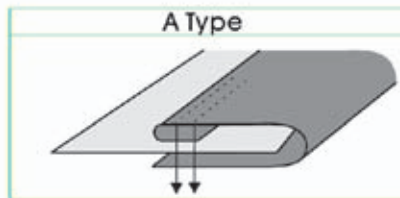

A Type

Tape Size	Finished Size
13/16"	20mm 1/4" 6mm
1"	25mm 5/16" 8mm
1 3/16"	30mm 3/8" 10mm
1 1/4"	32mm 7/16" 12mm
1 3/8"	35mm 1/2" 13mm
1 1/2"	38mm 9/16" 14mm
1 9/16"	40mm 19/32" 15mm
1 9/16"	40mm 5/8" 16mm
1 5/8"	42mm 11/16" 17mm
1 3/4"	45mm 11/16" 18mm
1 7/8"	48mm 3/4" 19mm
2"	50mm 13/16" 20mm
2 3/16"	55mm 7/8" 22mm
2 3/8"	60mm 1" 25mm
2 9/16"	65mm 1 1/8" 28mm
2 3/4"	70mm 1 3/16" 30mm
3"	75mm 1 1/4" 32mm
3"	75mm 1 5/16" 34mm

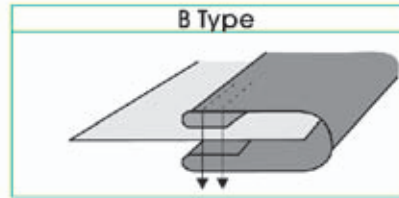

B Type

Tape Size	Finished Size
1"	25mm 1/4" 6mm
1 3/16"	30mm 5/16" 8mm
1 3/8"	35mm 3/8" 10mm
1 9/16"	40mm 7/16" 12mm
1 9/16"	40mm 1/2" 13mm
1 3/4"	45mm 9/16" 14mm
2"	50mm 5/8" 16mm
2 3/16"	55mm 11/16" 18mm
2 3/8"	60mm 13/16" 20mm
2 9/16"	65mm 7/8" 22mm
2 3/4"	70mm 1" 25mm
3"	75mm 1 1/8" 28mm



© Great Knives Manufacture Co., Ltd.

The trademark and artworks are the intellectual property which is preserved by GREAT KNIVES MANUFACTURE Co., Ltd. All offense against the copyright will be sued by the owner.

PARTS NO SW75D SINGLE DOWNTURN HEMMER

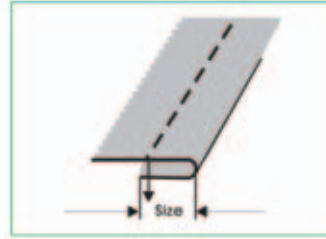
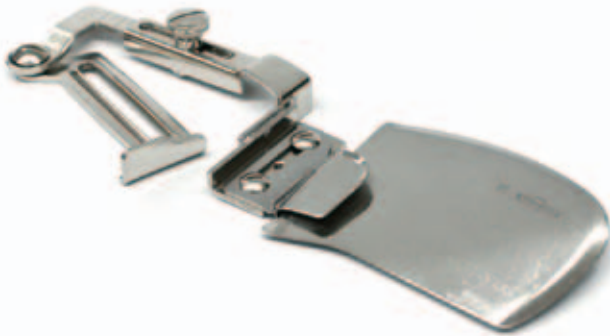

Tape Size

SW75D 1/2"

SW75D 1/4"

SW75D 3/8"

PARTS NO SW75U SINGLE UPTURN HEMMER

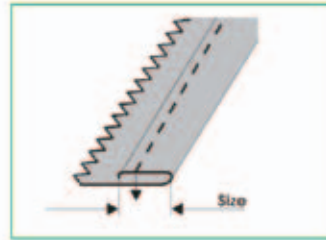

Tape Size

SW75U 1/2"

SW75U 1/4"

SW75U 3/8"

PARTS NO FA337 UNION-SP DOUBLE LAP SEAM FOLDER



Tape Size

FA337 7/16" M

FA337 7/16" MH

FA337 7/16" H



© Great Knives Manufacture Co., Ltd.

The trademark and artworks are the intellectual property which is preserved by GREAT KNIVES MANUFACTURE Co., Ltd. All offense against the copyright will be sued by the owner.

PARTS NO WB301 WAIST BAND FOLDER

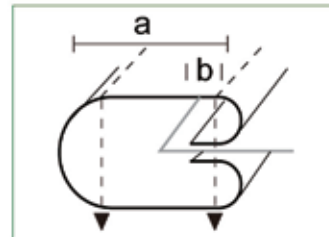

b:3/8" WB301 Tape Size

a:1"	IN:2 3/4"	a:1 1/2"	IN:3 3/4"
a:1	IN:3"	a:1 5/8"	IN:4"
a:3/16"	IN:3 1/8"	a:1 3/4"	IN:4 1/4"
a:1 1/4"	IN:3 1/4"	a:1 7/8"	IN:4 1/2"
a:1 3/8"	IN:3 1/2"	a:2"	IN:4 3/4"

PARTS NO WB302 WAIST BAND FOLDER WITH LINING

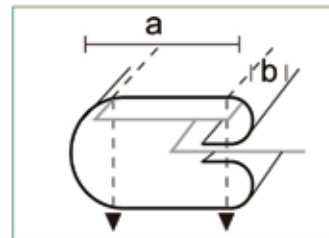

b:3/8" WB302 Tape Size

a:1"	IN:2 3/4"	a:1 1/2"	IN:3 3/4"
a:1 1/2"	IN:3"	a:1 5/8"	IN:4"
a:1 3/16"	IN:3 1/8"	a:1 3/4"	IN:4 1/4"
a:1 1/4"	IN:3 1/4"	a:1 7/8"	IN:4 1/2"
a:1 3/8"	IN:3 1/2"	a:2"	IN:4 3/4"

PARTS NO WB307 TWO PIECES WAIST BAND FOLDER

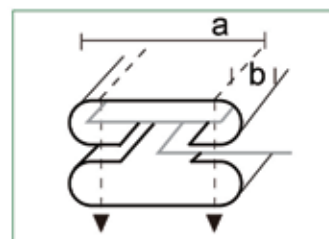

b:3/8" WB307 Tape Size

a:1"	IN:1 3/4"	a:1 1/2"	IN:2 1/4"
a:1 1/8"	IN:1 7/8"	a:1 5/8"	IN:2 3/8"
a:1 3/16"	IN:1 15/16"	a:1 3/4"	IN:2 1/2"
a:1 1/4"	IN:2"	a:1 7/8"	IN:2 5/8"
a:1 3/8"	IN:2 1/8"	a:2"	IN:2 3/4"



© Great Knives Manufacture Co., Ltd.

The trademark and artworks are the intellectual property which is preserved by GREAT KNIVES MANUFACTURE Co., Ltd. All offense against the copyright will be sued by the owner.

PARTS NO WB308 TWO PIECES CURVE WAIST BAND FOLDER

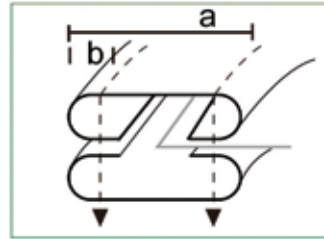

b:1/2" WB308 Tape Size

a:1 1/4"	IN:2 1/4"	a:1 5/8"	IN:2 5/8"
a:1 3/8"	IN:2 3/8"	a:1 3/4"	IN:2 3/4"
a:1 1/2"	IN:2 1/2"		

PARTS NO WB309 TWO PIECES WAIST BAND FOLDER

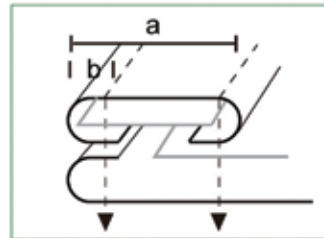

b:3/8" WB309 Tape Size

a:1"	IN:1 3/4"	a:1 1/2"	IN:2 1/4"
a:1 1/8"	IN:1 7/8"	a:1 5/8"	IN:2 3/8"
a:1 3/16"	IN:1 15/16"	a:1 3/4"	IN:2 1/2"
a:1 1/4"	IN:2"	a:1 7/8"	IN:2 5/8"
a:1 3/8"	IN:2 1/8"	a:2"	IN:2 3/4"

PARTS NO WB313 BOTTOM WAIST BAND FOLDER

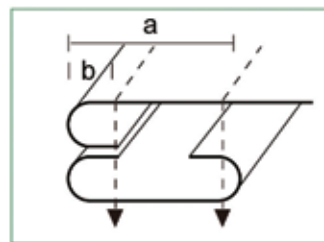

b:1/2" WB313 Tape Size

a:1"	IN:1 3/4"	a:1 1/2"	IN:2 1/2"	
a:1 1/8"	IN:1 7/8"	a:1 5/8"	IN:2 5/8"	
a:1 3/16"	IN:1 15/16"	a:1 3/4"	IN:2 3/4"	
a:1 1/4"	IN:2 1/4"	a:1 7/8"	IN:2 7/8"	
*b:3/8"	a:1 3/8"	IN:2 3/8"	a:2"	IN:3"



© Great Knives Manufacture Co., Ltd.

The trademark and artworks are the intellectual property which is preserved by GREAT KNIVES MANUFACTURE Co., Ltd. All offense against the copyright will be sued by the owner.

PARTS NO BL340 BELT LOOP FOLDER

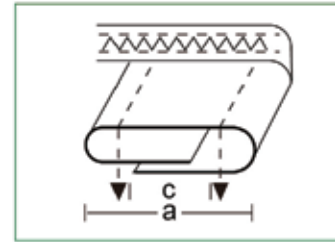

c: 1/4" **BL340 Tape Size**

a: 3/8"	IN: 7/8"	a: 3/4"	IN: 1 5/8"
a: 1/2"	IN: 1 1/8"	a: 7/8"	IN: 1 7/8"
a: 5/8"	IN: 1 3/8"	a: 1"	IN: 2 1/8"

PARTS NO BL342 BELT LOOP FOLDER

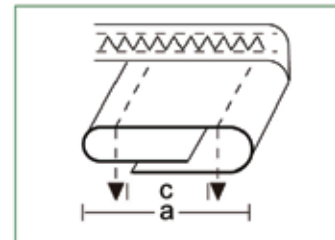

c: 1/4" **BL342 Tape Size**

a: 3/8"	IN: 7/8"	a: 5/8"	IN: 1 3/8"
a: 1/2"	IN: 1 1/8"	a: 3/4"	IN: 1 5/8"

PARTS NO CP203 TOP CENTER PLAID HEMMER

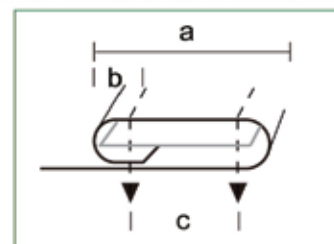

b: 1/2" **CP203 Tape Size**

a: 7/8"	c: 1/2~3/4"	a: 1 3/8"	c: 7/8~1 1/4"
a: 1"	c: 1/2~7/8"	a: 1 1/2"	c: 1~1 3/8"
a: 1 1/8"	c: 5/8~1"	a: 1 5/8"	c: 1 1/8~1 1/2"
a: 1 3/16"	c: 11/16~1 1/16"	a: 1 3/4"	c: 1 1/4~1 5/8"
a: 1 1/4"	c: 3/4~1 1/8"		



© Great Knives Manufacture Co., Ltd.

The trademark and artworks are the intellectual property which is preserved by GREAT KNIVES MANUFACTURE Co., Ltd. All offense against the copyright will be sued by the owner.

PARTS NO BS333 LAP SEAM FOLDER

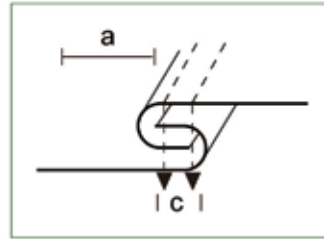

BS333 Tape Size

a:5/16"	c:3/16"
a:3/8"	c:1/4"

PARTS NO BS334 SPRING TYPE LAP SEAM FOLDER

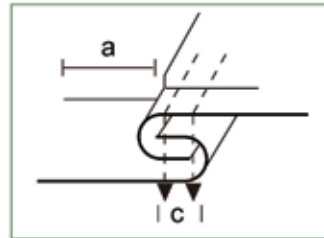

BS334 Tape Size

a:5/16"	c:3/16"
a:3/8"	c:1/4"

PARTS NO CP201 TOP CENTER PLAIT FOLDER

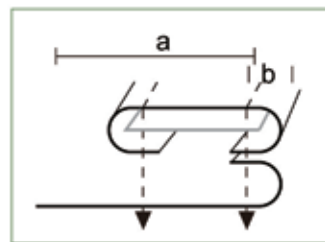

b:1/2" CP201 Tape Size

* a:7/8"	IN:1 5/8"	a:1 3/8"	IN:2 3/8"
* a:1"	IN:1 3/4"	a:1 1/2"	IN:2 1/2"
* a:1 1/8"	IN:1 7/8"	a:1 5/8"	IN:2 5/8"
a:1 3/16"	IN:2 3/16"	a:1 3/4"	IN:2 3/4"
*b:3/8"	a:1 1/4"	IN:2 1/4"	



© Great Knives Manufacture Co., Ltd.

The trademark and artworks are the intellectual property which is preserved by GREAT KNIVES MANUFACTURE Co., Ltd. All offense against the copyright will be sued by the owner.

PARTS NO CP204 IMITATION FOLDER

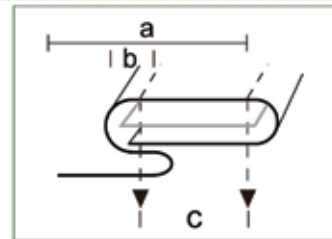

CP204 Tape Size

a:1"	b:1/4"	c:5/8"	a:1 1/4"	b:5/16"	c:3/4"
a:1"	b:5/16"	c:1/2"	a:1 3/8"	b:1/4"	c:1"
a:1 1/8"	b:1/4"	c:3/4"	a:1 3/8"	b:5/16"	c:7/8"
a:1 1/8"	b:5/16"	c:5/8"	a:1 1/2"	b:1/4"	c:1 1/8"
a:1 3/16"	b:1/4"	c:13/16"	a:1 1/2"	b:5/16"	c:1"
a:1 3/16"	b:5/16"	c:11/16"	a:1 5/8"	b:1/4"	c:1 1/4"
a:1 1/4"	b:1/4"	c:7/8"	a:1 5/8"	b:5/16"	c:1 1/8"

PARTS NO CP206 PLAIT FOLDER

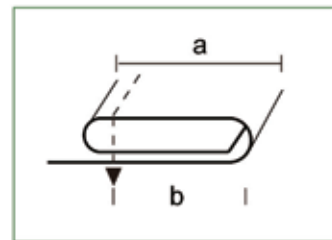

CP206 Tape Size

a:7/8"	b:13/16"	a:1 1/4"	IN:1 3/16"
a:1"	b:15/16"	a:1 3/8"	IN:1 5/16"
a:1 1/8"	b:1 1/16"	a:1 1/2"	IN:1 7/16"
a:1 3/16"	b:1 1/8"		

PARTS NO BP207 PLAIT FOLDER WITH INTERLINING

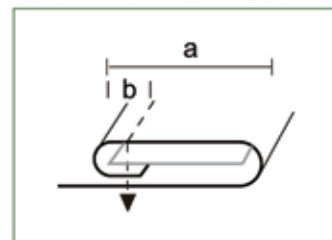

b:3/8" BP207 Tape Size

a:3/4"	a:1 3/16"
a:7/8"	a:1 1/4"
a:1"	a:1 3/8"
a:1 1/8"	a:1 1/2"



© Great Knives Manufacture Co., Ltd.

The trademark and artworks are the intellectual property which is preserved by GREAT KNIVES MANUFACTURE Co., Ltd. All offense against the copyright will be sued by the owner.

PARTS NO ST211 SINGLE NEEDLE SHOULDER TOP STITCH ATTACHMENT

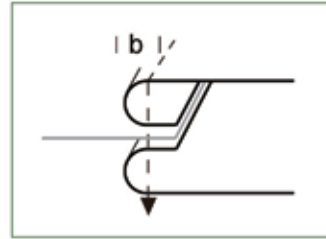

ST211 Tape Size

b:3/8

PARTS NO RS219 SLEEVE PLACKET BINDER

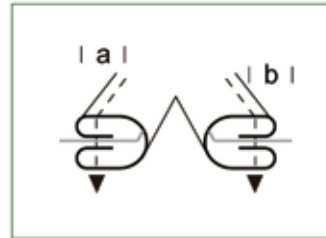

RS219 Tape Size

a:1/4"	b:1/4"	IN:1"	a:5/8"	b:3/8"	IN:2"
a:5/16"	b:1/4"	IN:1 1/8"	a:3/4"	b:3/8"	IN:2 1/4"
a:3/8"	b:1/4"	IN:1 1/4"	a:7/8"	b:3/8"	IN:2 1/2"
a:1/2"	b:1/4"	IN:1 1/2"	a:1"	b:3/8"	IN:2 3/4"

PARTS NO SH502 SWING HEMMER FOOT

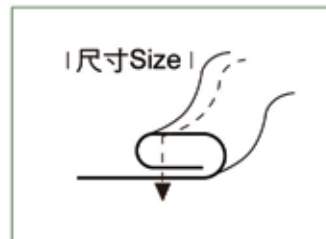

SH502 Tape Size

1/8"

3/16"

1/4"



© Great Knives Manufacture Co., Ltd.

The trademark and artworks are the intellectual property which is preserved by GREAT KNIVES MANUFACTURE Co., Ltd. All offense against the copyright will be sued by the owner.

PARTS NO CH503 SHORT TAIL SWING HEMMER

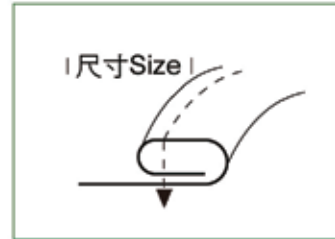

SH503 Tape Size

- 1/8"
- 3/16"
- 1/4"
- 5/16"

PARTS NO CH504 SPRING TYPE SWING HEMMER

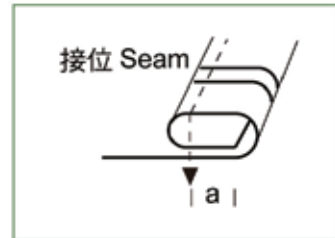

SH504 Tape Size

- 1/8"
- 3/16"
- 1/4"
- 5/16"
- 3/8"

PARTS NO CB501 SINGLE UP TURN FOLDER

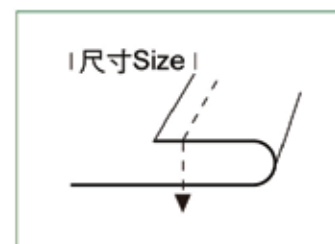

CB501 Tape Size

3/16"	3/4"
1/4"	1"
5/16"	1 1/4"
3/8"	1 1/2"
1/2"	



© Great Knives Manufacture Co., Ltd.

The trademark and artworks are the intellectual property which is preserved by GREAT KNIVES MANUFACTURE Co., Ltd. All offense against the copyright will be sued by the owner.

PARTS NO BK213 SINGLE NEEDLE SHIRT YOKE ATTACHMENT

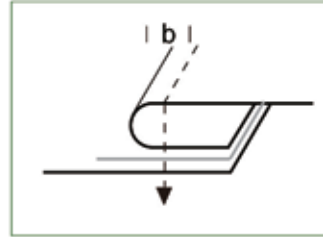

BK213 Tape Size
b:3/8"

PARTS NO LO515 LOOP FOLDER FOOT

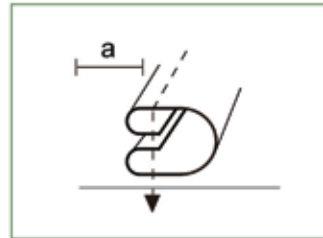

LO515 Tape Size
a:1/8" IN:1/2"
a:3/16" IN:3/4"
a:1/4" IN:1"

PARTS NO LO516 LOOP FOLDER

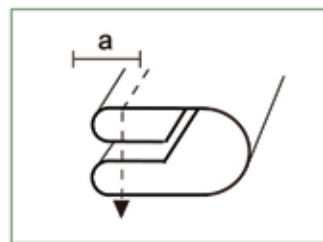

LO515 Tape Size
a:3/16" IN:3/4"
a:1/4" IN:1"
a:5/16" IN:1 1/4"
a:3/8" IN:1 3/8"



© Great Knives Manufacture Co., Ltd.

The trademark and artworks are the intellectual property which is preserved by GREAT KNIVES MANUFACTURE Co., Ltd. All offense against the copyright will be sued by the owner.

PARTS NO LO535 SPAGHETTI ATTACHMENT

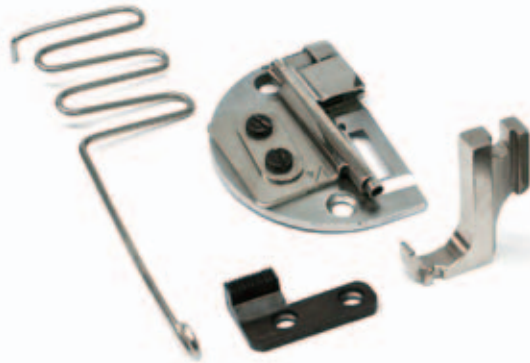

LO515 Tape Size

a:1/8"	IN:5/8"	a:5/16"	IN:1 1/4"
a:3/16"	IN:7/8"	a:3/8"	IN:1 3/8"
a:1/4"	IN:1"	a:1/2"	IN:1 3/4"

PARTS NO EB531 EDGE BINDER



EB531 Tape Size

a:3/16"	IN:3/8"
a:1/4"	IN:1/2"
a:5/16"	IN:5/8"
a:3/8"	IN:3/4"



© Great Knives Manufacture Co., Ltd.

The trademark and artworks are the intellectual property which is preserved by GREAT KNIVES MANUFACTURE Co., Ltd. All offense against the copyright will be sued by the owner.

PARTS NO		HEMMER FEET		
				
1	1 1/2	2	2 1/2	02
1.6mm 1/16"	2.0mm 5/64"	2.4mm 3/32"	3.2mm 1/8"	3.2mm 1/8"
				
3	4	04	5	6
4.0mm 5/32"	4.8mm 3/16"	4.8mm 3/16"	5.6mm 7/32"	6.4mm 1/4"
				
06	7 1/2	07	09	095
6.4mm 1/4"	8.0mm 5/16"	8.0mm 5/16"	9.5mm 3/8"	11.1mm 7/16"



© Great Knives Manufacture Co., Ltd.

The trademark and artworks are the intellectual property which is preserved by GREAT KNIVES MANUFACTURE Co., Ltd. All offense against the copyright will be sued by the owner.



SUCTION-TYPE CHAIN CUTTER

JUKI 60
PEGASUS 61



© Great Knives Manufacture Co., Ltd.

The trademark and artworks are the intellectual property which is preserved by
GREAT KNIVES MANUFACTURE Co., Ltd. All offense against
the copyright will be sued by the owner.

<<SUCTION-TYPE CHAIN CUTTERS

-59-

FOR JUKI



MAT-035000AO
T035

Flat Chain Cutter



MAT-041000AO
T041

Flat Chain Cutter



MAT-041000AO-A
T041-A

Flat Chain Cutter



MAT-041000AB
T041-AB

Flat Chain Cutter



MATC220000AO
T022

Flat Chain Cutter



T042

Side Chain Cutter



© Great Knives Manufacture Co., Ltd.

The trademark and artworks are the intellectual property which is preserved by GREAT KNIVES MANUFACTURE Co., Ltd. All offense against the copyright will be sued by the owner.

FOR JUKI



MAT-02203000

Moving Knife Carbide



MAT-03506000

Moving Knife Carbide



MAT-02204000

Fixed Knife Carbide



MAT-03505000

Fixed Knife Carbide

FOR PEGASUS



KH303753

Flat Chain Cutter



KH303754

Flat Chain Cutter



© Great Knives Manufacture Co., Ltd.

The trademark and artworks are the intellectual property which is preserved by GREAT KNIVES MANUFACTURE Co., Ltd. All offense against the copyright will be sued by the owner.

FOR PEGASUS



KH301030

Flat Chain Cutter



KH301235

Flat Chain Cutter

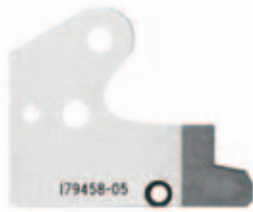

179458-05

Fixed Knife Carbide

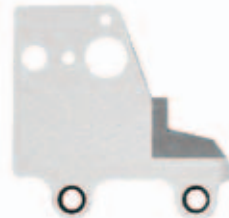

308026-91

Fixed Knife Carbide



301035

Fixed Knife Carbide



301006

Fixed Knife Carbide



© Great Knives Manufacture Co., Ltd.

The trademark and artworks are the intellectual property which is preserved by GREAT KNIVES MANUFACTURE Co., Ltd. All offense against the copyright will be sued by the owner.

FOR PEGASUS



KS301148

Side Chain Cutter



308030

Moving Knife Carbide



179459-05

Moving Knife Carbide



301036

Moving Knife Carbide

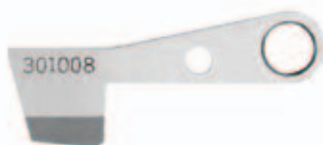

301008

Moving Knife Carbide



© Great Knives Manufacture Co., Ltd.

The trademark and artworks are the intellectual property which is preserved by GREAT KNIVES MANUFACTURE Co., Ltd. All offense against the copyright will be sued by the owner.

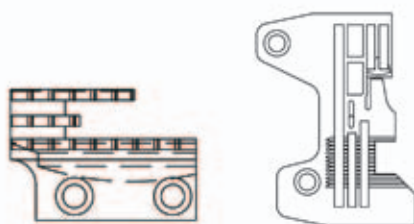

NEEDLE PLATE & FEED DOG SERIES

BROTHER	65
JUKI	66
KANSAI	71
YAMATO	73
PEGASUS	75
SIRUBA	81
OTHERS	85



© Great Knives Manufacture Co., Ltd.

The trademark and artworks are the intellectual property which is preserved by
GREAT KNIVES MANUFACTURE Co., Ltd. All offense against
 the copyright will be sued by the owner.

FOR BROTHER



S08723-001
S08724-001
Needle Plate



S08731-001
S08732-001
Needle Plate

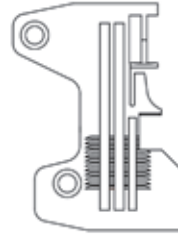

S19145-001
S19146-001
Needle Plate

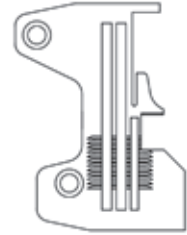

S19154-001
S19155-001
Needle Plate

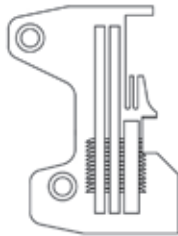

S19166-001
Needle Plate

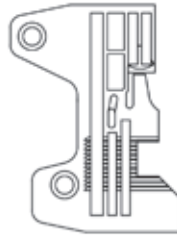

S19185-001
Needle Plate

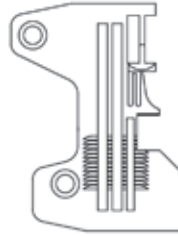

S25190-001
Needle Plate

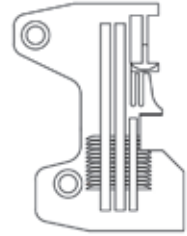

S19162-001
Needle Plate

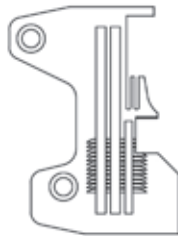

S19169-001
Needle Plate

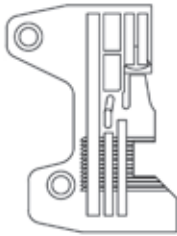

S19186-001
Needle Plate

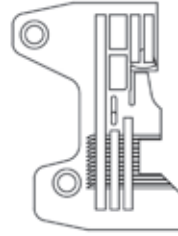

S20232-001
S20234-001
S20236-001
Needle Plate



S10570-001 1/8"
Needle Plate



© Great Knives Manufacture Co., Ltd.

The trademark and artworks are the intellectual property which is preserved by GREAT KNIVES MANUFACTURE Co., Ltd. All offense against the copyright will be sued by the owner.

FOR BROTHER



S08882-001

Feed Dog

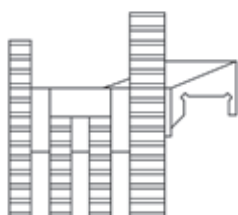

S08883-001

Feed Dog



S20241-101

Feed Dog

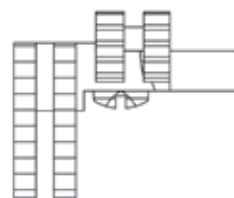

S19199-001

Feed Dog

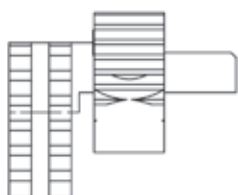

S19202-001

Feed Dog

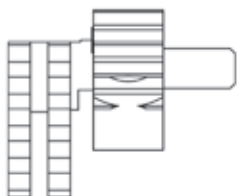

S19212-001

Feed Dog

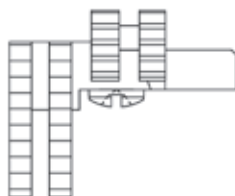

S19217-001

Feed Dog



S19219-001

Feed Dog

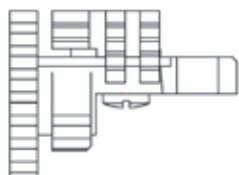

S19228-101

Feed Dog



S19236-001
S19240-001

Feed Dog



S19237-001

Feed Dog



S19244-001

Feed Dog



© Great Knives Manufacture Co., Ltd.

The trademark and artworks are the intellectual property which is preserved by GREAT KNIVES MANUFACTURE Co., Ltd. All offense against the copyright will be sued by the owner.

FOR BROTHER



S19247-001

Feed Dog

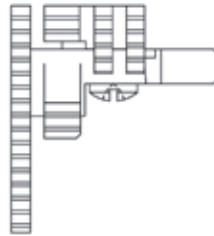

S20239-101

Feed Dog



S20245-001

Feed Dog



S10605-001

Counter Knife



S10572-001 3/16"

Needle Plate



S10573-001 1/4"

Needle Plate



© Great Knives Manufacture Co., Ltd.

The trademark and artworks are the intellectual property which is preserved by
GREAT KNIVES MANUFACTURE Co., Ltd. All offense against
 the copyright will be sued by the owner.

<<NEEDLE PLATE, FEED DOG

FOR JUKI

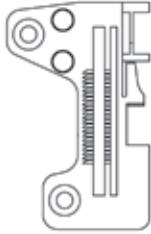

R4200-HOD-DOO

Needle Plate

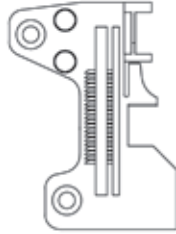

R4200-JOE-DOO

Needle Plate

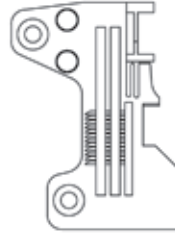

R4305-JOE-EOO

Needle Plate

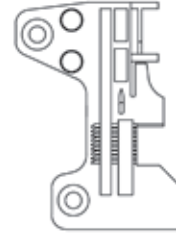

R4508-JOE-DOO

Needle Plate

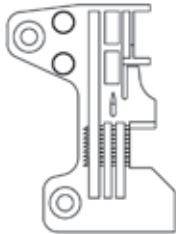

R4608-JOE-DOO

Needle Plate

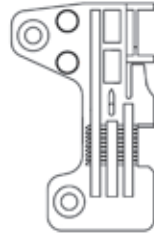

R4612-HOF-GOO

Needle Plate

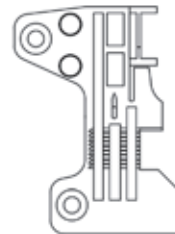

R4612-JOF-DOO

Needle Plate

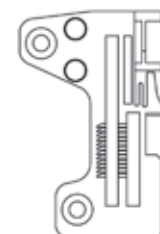

R4205-HOD-EAO

Needle Plate

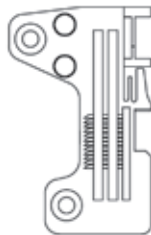

R4305-HOD-EOO

Needle Plate



R4508-HOD-DOO

Needle Plate

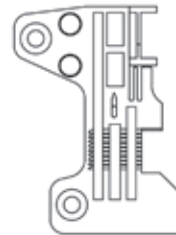

R4612-JOD-E01

Needle Plate



B4145-530-BOO

Counter Knife



© Great Knives Manufacture Co., Ltd.

The trademark and artworks are the intellectual property which is preserved by GREAT KNIVES MANUFACTURE Co., Ltd. All offense against the copyright will be sued by the owner.

FOR JUKI



B1190-522-SOO 1/8"
B1190-522-TOO 3/16"
Needle Plate



B1190-522-UOO 1/4"
Needle Plate



B1190-522-VOO 3/8"
B1190-522-YOB 5/16"
Needle Plate

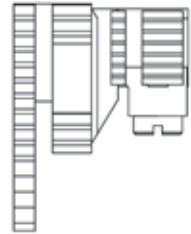

118-84004+
118-87403
Feed Dog

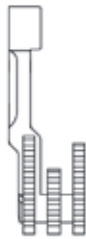

118-85407
Feed Dog



118-86504
Feed Dog



119-49807+
118-87106
Feed Dog



119-49906
Feed Dog



121-72805
Feed Dog



121-73209
Feed Dog



121-73308
Feed Dog

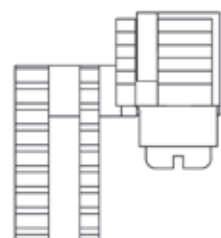

115-97101+
118-87106
Feed Dog



© Great Knives Manufacture Co., Ltd.

The trademark and artworks are the intellectual property which is preserved by GREAT KNIVES MANUFACTURE Co., Ltd. All offense against the copyright will be sued by the owner.

<<NEEDLE PLATE, FEED DOG

FOR JUKI

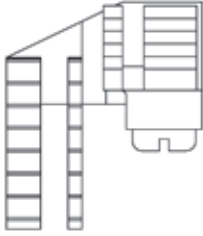

118-82107+
118-87106
Feed Dog



118-85209
Feed Dog



B1657-804-OOT
Feed Dog



B1657-814-BOE
Feed Dog

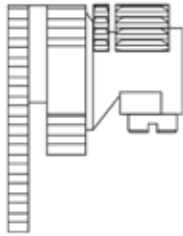

118-82909+
118-87106
Feed Dog

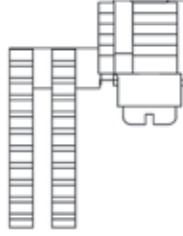

118-82404+
118-87106
Feed Dog



118-82800+
118-87403
Feed Dog

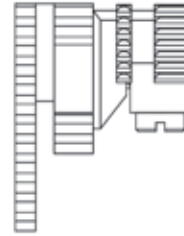

118-83006+
118-87304
Feed Dog



© Great Knives Manufacture Co., Ltd.

The trademark and artworks are the intellectual property which is preserved by GREAT KNIVES MANUFACTURE Co., Ltd. All offense against the copyright will be sued by the owner.

FOR KANSAI-SP



14-7900-0
14-7910-0

Needle Plate



14-8540-0

Needle Plate

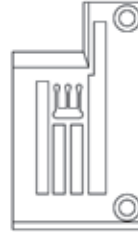

14-8560-0

Needle Plate

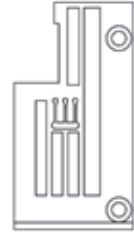

14-8580-0

Needle Plate



14-8640-0

Needle Plate

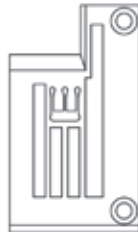

14-8660-0

Needle Plate

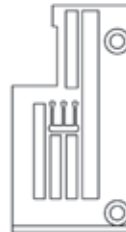

14-8680-0

Needle Plate

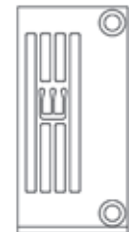

14-8900-0
14-8910-0

Needle Plate



14-8190-0
14-8200-0

Needle Plate



14-8460-0
14-8470-0

Needle Plate

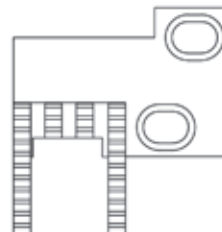

15-7530-0

Feed Dog

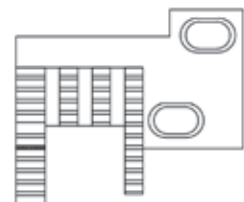

15-7560-0

Feed Dog



© Great Knives Manufacture Co., Ltd.

The trademark and artworks are the intellectual property which is preserved by GREAT KNIVES MANUFACTURE Co., Ltd. All offense against the copyright will be sued by the owner.

FOR

KANSAI-SP

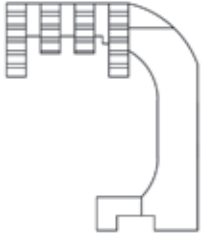

15-7230-0

Feed Dog



15-7270-0

Feed Dog

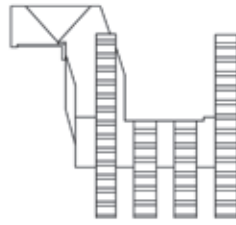

15-8070-0

Feed Dog

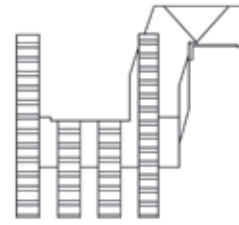

15-808

Feed Dog

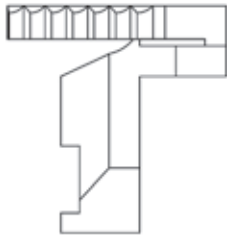

15-8110-0

Feed Dog



15-8120-0

Feed Dog

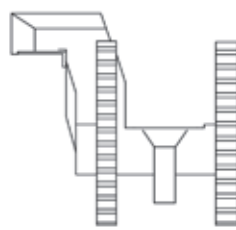

15-8230-0

Feed Dog



© Great Knives Manufacture Co., Ltd.

The trademark and artworks are the intellectual property which is preserved by GREAT KNIVES MANUFACTURE Co., Ltd. All offense against the copyright will be sued by the owner.

FOR YAMATO

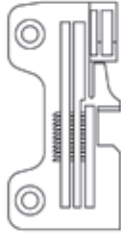

2108003

Needle Plate

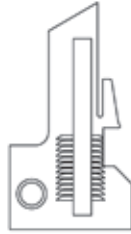

32667

Needle Plate



34598

Needle Plate



94902

Needle Plate

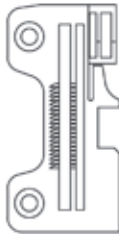

2108000

Needle Plate

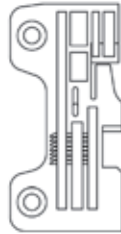

2108052

Needle Plate



32672

Needle Plate



33353

Needle Plate



33545

Needle Plate



94801
94802

Needle Plate

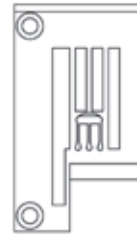

95085

Needle Plate

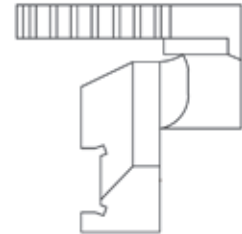

3209009

Feed Dog



© Great Knives Manufacture Co., Ltd.

The trademark and artworks are the intellectual property which is preserved by GREAT KNIVES MANUFACTURE Co., Ltd. All offense against the copyright will be sued by the owner.

FOR YAMATO



2109000

Feed Dog



2109005

Feed Dog



2109006 +
2109067

Feed Dog



2109055

Feed Dog

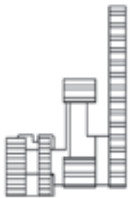

2109056 +
2109052

Feed Dog



3109002

Feed Dog



3109003

Feed Dog



3209008

Feed Dog



3209000

Feed Dog



3209001

Feed Dog



3209002

Feed Dog



3209003

Feed Dog



© Great Knives Manufacture Co., Ltd.

The trademark and artworks are the intellectual property which is preserved by GREAT KNIVES MANUFACTURE Co., Ltd. All offense against the copyright will be sued by the owner.

FOR YAMATO



3109000

Feed Dog

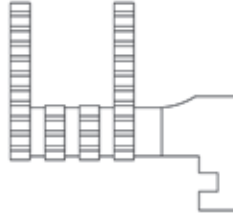

3109001

Feed Dog

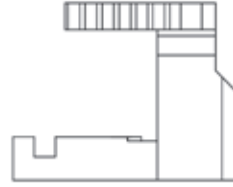

3109020

Feed Dog



3109021

Feed Dog

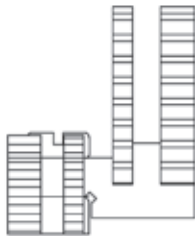

2109001 +
2109067

Feed Dog



© Great Knives Manufacture Co., Ltd.

The trademark and artworks are the intellectual property which is preserved by GREAT KNIVES MANUFACTURE Co., Ltd. All offense against the copyright will be sued by the owner.

<<NEEDLE PLATE, FEED DOG

FOR PEGASUS

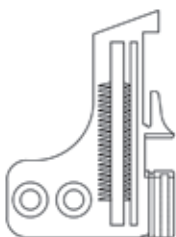

202618A

Needle Plate

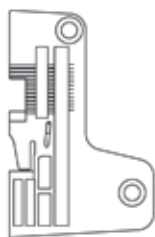

204360A

Needle Plate

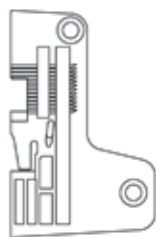

204528

Needle Plate

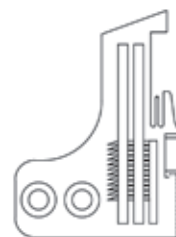

205255

Needle Plate

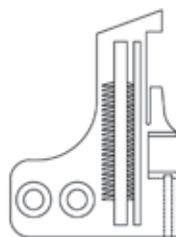

205773

Needle Plate

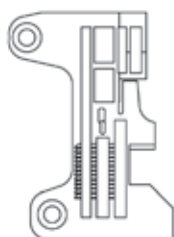

277516R50
277516R60

Needle Plate

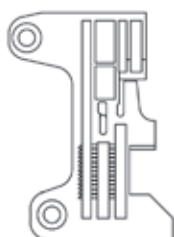

277524T50
277524T60

Needle Plate

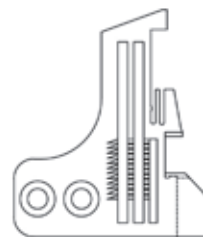

202554E-1

Needle Plate

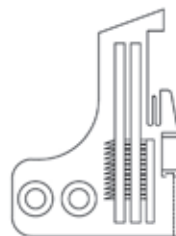

202554E

Needle Plate



202675

Needle Plate



202702

Needle Plate

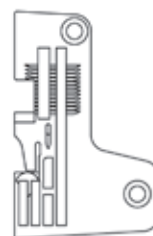

204367

Needle Plate



© Great Knives Manufacture Co., Ltd.

The trademark and artworks are the intellectual property which is preserved by GREAT KNIVES MANUFACTURE Co., Ltd. All offense against the copyright will be sued by the owner.

FOR PEGASUS

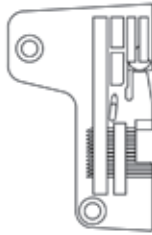

204529

Needle Plate



257018B56
257018B64

Needle Plate



257033B56
257033B64

Needle Plate

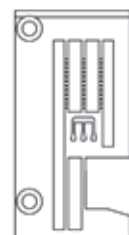

257053B56
257053B64

Needle Plate

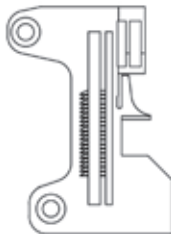

277500P30
277500P40

Needle Plate

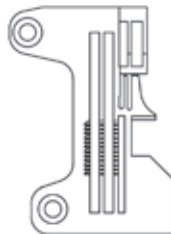

277505R30
277505R40
277505R50

Needle Plate

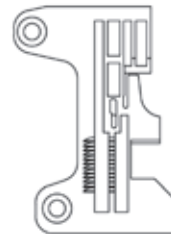

277513R30
277513R40
277513R50

Needle Plate

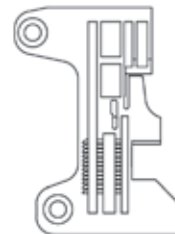

277517R40
277517R50

Needle Plate



© Great Knives Manufacture Co., Ltd.

The trademark and artworks are the intellectual property which is preserved by GREAT KNIVES MANUFACTURE Co., Ltd. All offense against the copyright will be sued by the owner.

FOR PEGASUS



201094B

Feed Dog



202854A

Feed Dog



204730A16F

Feed Dog

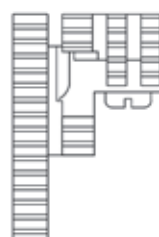

208063

Feed Dog

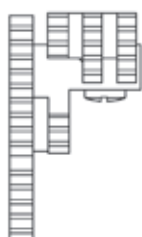

208066

Feed Dog

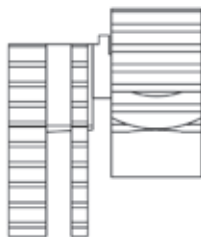

208090A16F

Feed Dog

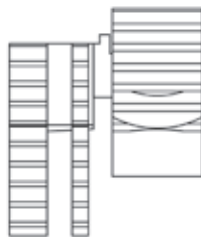

208090-BF

Feed Dog

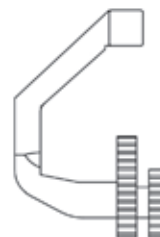

208215

Feed Dog

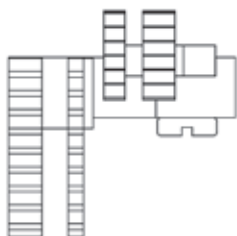

277300-16

Feed Dog

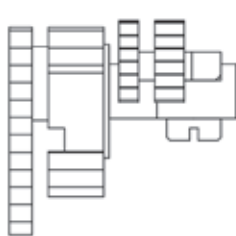

277327-16

Feed Dog



277329-16

Feed Dog



277330-16

Feed Dog



© Great Knives Manufacture Co., Ltd.

The trademark and artworks are the intellectual property which is preserved by GREAT KNIVES MANUFACTURE Co., Ltd. All offense against the copyright will be sued by the owner.

FOR PEGASUS



S08885-001

Feed Dog



S08886-001

Feed Dog



204676-BF

Feed Dog



204730-BF

Feed Dog

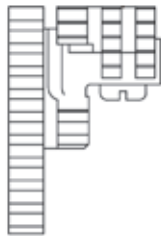

208064

Feed Dog

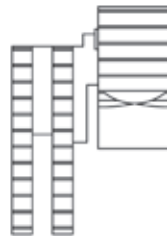

208078-BF

Feed Dog

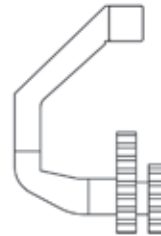

208217

Feed Dog

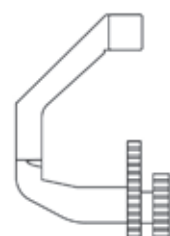

208219

Feed Dog



257207-16F

Feed Dog

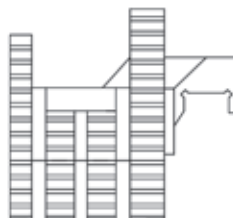

257216-16F

Feed Dog

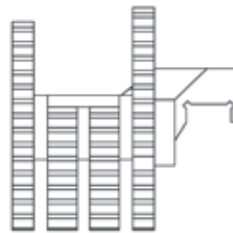

257222-16F

Feed Dog



257259-16F

Feed Dog



© Great Knives Manufacture Co., Ltd.

The trademark and artworks are the intellectual property which is preserved by GREAT KNIVES MANUFACTURE Co., Ltd. All offense against the copyright will be sued by the owner.

FOR PEGASUS



277305-16

Feed Dog

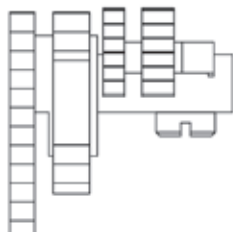

277323-16

Feed Dog



277325-16

Feed Dog

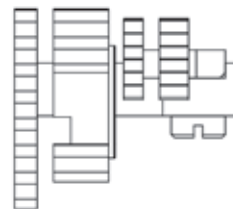

277337-25

Feed Dog



277339-25

Feed Dog



257262-16F

Feed Dog

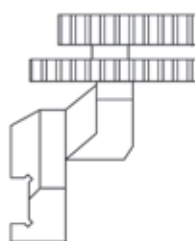

257268-16F

Feed Dog



277302-16

Feed Dog

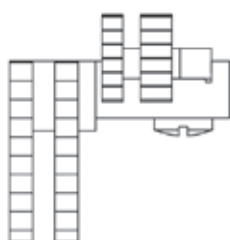

277303-16

Feed Dog



© Great Knives Manufacture Co., Ltd.

The trademark and artworks are the intellectual property which is preserved by GREAT KNIVES MANUFACTURE Co., Ltd. All offense against the copyright will be sued by the owner.

FOR SIRUBA



E591B

Needle Plate



E854

Needle Plate



**E1826
E1827**

Needle Plate

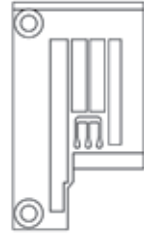

**E3326
E3327**

Needle Plate



E3524P

Needle Plate



**E3826P
E3827P**

Needle Plate

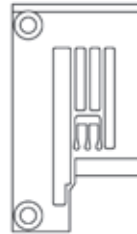

**E4426P
E4427P**

Needle Plate



**E4826
E4827**

Needle Plate

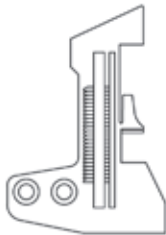

E784

Needle Plate



E797

Needle Plate

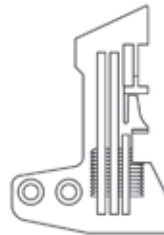

E800

Needle Plate

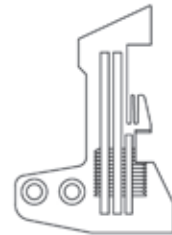

E805

Needle Plate



© Great Knives Manufacture Co., Ltd.

The trademark and artworks are the intellectual property which is preserved by GREAT KNIVES MANUFACTURE Co., Ltd. All offense against the copyright will be sued by the owner.

FOR SIRUBA

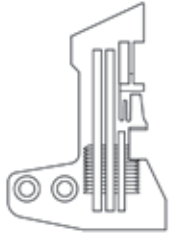

E809

Needle Plate

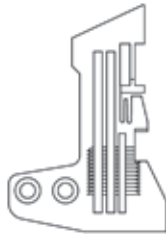

E810

Needle Plate

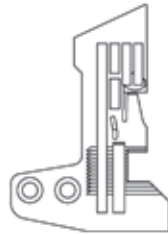

E839

Needle Plate

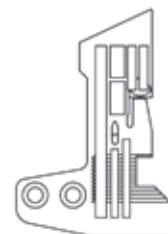

E868

Needle Plate

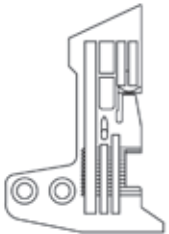

E870

Needle Plate

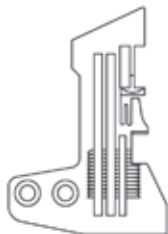

E919
E920

Needle Plate

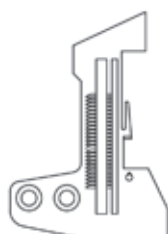

E934

Needle Plate

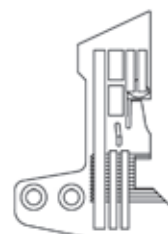

E982

Needle Plate

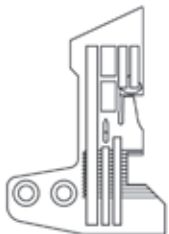

E986

Needle Plate



© Great Knives Manufacture Co., Ltd.

The trademark and artworks are the intellectual property which is preserved by GREAT KNIVES MANUFACTURE Co., Ltd. All offense against the copyright will be sued by the owner.

FOR SIRUBA

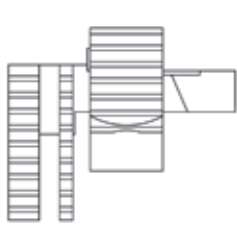

D290

Feed Dog

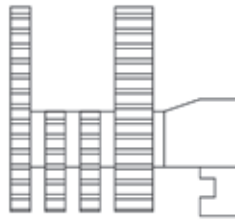

D3216

Feed Dog

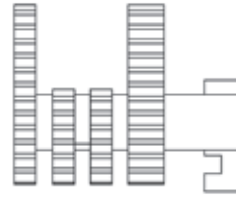

D3217

Feed Dog

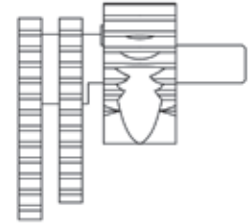

D390

Feed Dog

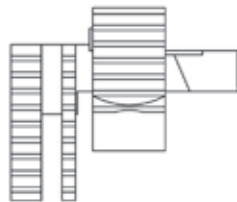

D569

Feed Dog

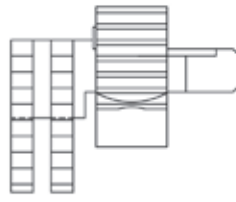

D574

Feed Dog



H1259

Feed Dog

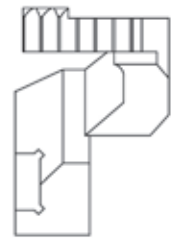

H1262

Feed Dog

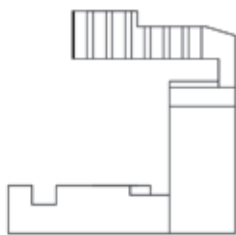

H3362

Feed Dog

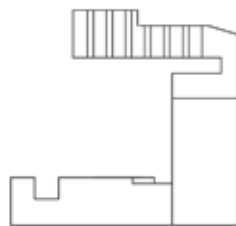

H3363

Feed Dog



H4258

H4259

Feed Dog



H442

H492

Feed Dog



© Great Knives Manufacture Co., Ltd.

The trademark and artworks are the intellectual property which is preserved by GREAT KNIVES MANUFACTURE Co., Ltd. All offense against the copyright will be sued by the owner.

FOR SIRUBA



H500
H501
Feed Dog



H974
Feed Dog

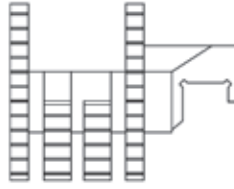

D1207
Feed Dog

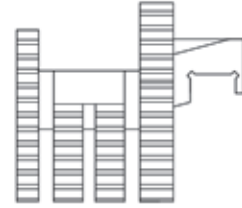

D1216
Feed Dog



D4206
Feed Dog

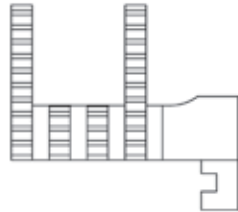

D4207
Feed Dog

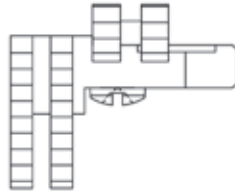

D575
Feed Dog

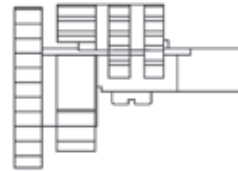

D581
D582
Feed Dog



H445
Feed Dog



H497
Feed Dog



H494
Feed Dog

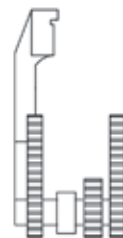

H1359
Feed Dog



© Great Knives Manufacture Co., Ltd.

The trademark and artworks are the intellectual property which is preserved by GREAT KNIVES MANUFACTURE Co., Ltd. All offense against the copyright will be sued by the owner.

FOR SINGLE NEEDLE LOCKSTITCH SEWING MACHINES



B14

Needle Plate



B16

Needle Plate



B18

Needle Plate



B20

Needle Plate



B22

Needle Plate

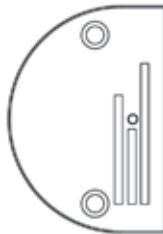

B24

Needle Plate

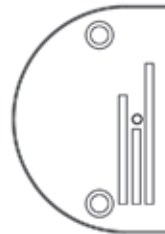

B26

Needle Plate



B28

Needle Plate



B30

Needle Plate



E14

Needle Plate

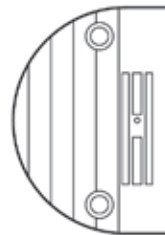

E16

Needle Plate



E18

Needle Plate



© Great Knives Manufacture Co., Ltd.

The trademark and artworks are the intellectual property which is preserved by GREAT KNIVES MANUFACTURE Co., Ltd. All offense against the copyright will be sued by the owner.

FOR SINGLE NEEDLE LOCKSTITCH SEWING MACHINES <<<



E20

Needle Plate

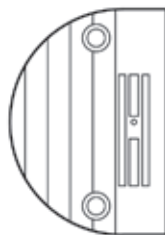

E22

Needle Plate

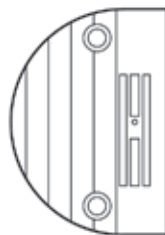

E24

Needle Plate



H26

Needle Plate



12482

Needle Plate

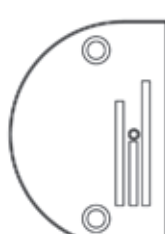

56065

Needle Plate

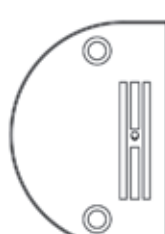

147150LGW

Needle Plate

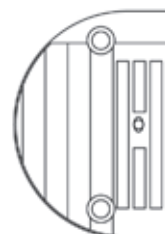

143169W

Needle Plate



B1109-555-HOB

Needle Plate

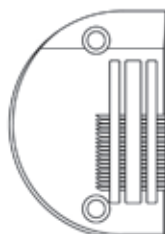

B1109-415-H00

Needle Plate



149057

Feed Dog

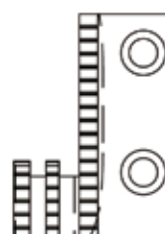

20002 FOR A10

Feed Dog



© Great Knives Manufacture Co., Ltd.

The trademark and artworks are the intellectual property which is preserved by GREAT KNIVES MANUFACTURE Co., Ltd. All offense against the copyright will be sued by the owner.

FOR SINGLE NEEDLE LOCKSTITCH SEWING MACHINES



272153

Feed Dog

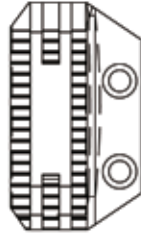

150793

Feed Dog

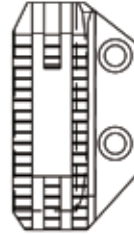

149165

Feed Dog

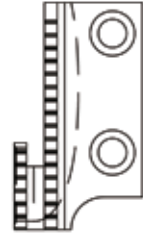

B1613-522-NOO

Feed Dog

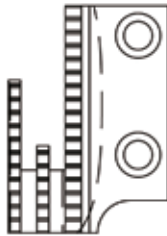

B1613-522-WOO

Feed Dog



A70 FEED DOG

Feed Dog



99801

Feed Dog

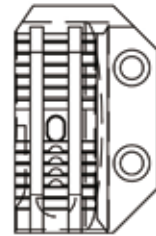

B1609-415-HOB

Feed Dog



A10-NP NO.1~4

Needle Plate



12481-9~22

Feed Dog



B1613-555-HOO

Feed Dog



© Great Knives Manufacture Co., Ltd.

The trademark and artworks are the intellectual property which is preserved by
GREAT KNIVES MANUFACTURE Co., Ltd. All offense against
 the copyright will be sued by the owner.

<<NEEDLE PLATE, FEED DOG



SCISSORS, GRINDING STONE, TOOL SERIES

HEX WRENCHES	89
TAGGING GUN	89
THREAD CLIPPER	90
SCISSORS	92
RING TYPE THREAD CUTTER	92
TAILOR SHEAR	93
GRINDING STONE	94
ABRASIVE BELTS	96
BAND KNIVES	97
CLEAN GUN	98



© Great Knives Manufacture Co., Ltd.

The trademark and artworks are the intellectual property which is preserved by GREAT KNIVES MANUFACTURE Co., Ltd. All offense against the copyright will be sued by the owner.

FOR HEX WRENCHES



99047-0-10



37919

FOR TAGGING GUN

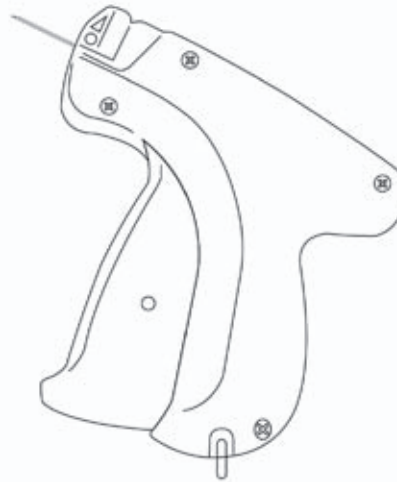

TG-88S-O
Orange



TG-88S-B
Blue



TG-88S-R
Red



© Great Knives Manufacture Co., Ltd.

The trademark and artworks are the intellectual property which is preserved by GREAT KNIVES MANUFACTURE Co., Ltd. All offense against the copyright will be sued by the owner.

FOR THREAD CLIPPERS TC-100



FOR THREAD CLIPPERS TC-801



© Great Knives Manufacture Co., Ltd.

The trademark and artworks are the intellectual property which is preserved by GREAT KNIVES MANUFACTURE Co., Ltd. All offense against the copyright will be sued by the owner.

FOR THREAD CUTTERS TC-805



TC-805

Golden



FOR THREAD CUTTERS TC-805B



TC-805B

Black

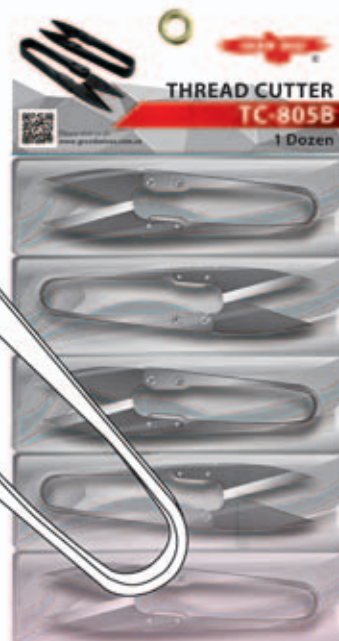

© Great Knives Manufacture Co., Ltd.

The trademark and artworks are the intellectual property which is preserved by GREAT KNIVES MANUFACTURE Co., Ltd. All offense against the copyright will be sued by the owner.

FOR THREAD CLIPPERS TC-808



MODEL NO.

- TC-808S-B(Black)
- TC 808SP(Silver)

FOR STAINLESS SCISSORS TC-S230

MODEL NO.

- TC-S230(Red)
- TC-S230(Blue)
- TC-S230(Orange)
- TC-S230(Turquoise)
- TC-S230(Purple)
- TC-S230(Mix)



Purple

Orange

Turquoise

Red

Blue

FOR RING TYPE THREAD CUTTERS



MODEL NO.

- TC-RG01Y(Yellow)
- TC-RG02B(Black)
- TC-RG03O(Orange)
- TC-RGMIX(Mix)



© Great Knives Manufacture Co., Ltd.

The trademark and artworks are the intellectual property which is preserved by GREAT KNIVES MANUFACTURE Co., Ltd. All offense against the copyright will be sued by the owner.

FOR TAILOR SHEAR

MODEL NO.	SIZES(Inch)
TC-P300	12"
TC-P280	11"
TC-P260	10"
TC-P240	9"
TC-P220	8"

TC-P300	12"
TC-P280	11"
TC-P260	10"
TC-P240	9"
TC-P220	8"

FOR PINKING SHEAR

MODEL NO.
TC-230
TC-230P-GE

TC-230
TC-230P-GE



© Great Knives Manufacture Co., Ltd.

The trademark and artworks are the intellectual property which is preserved by GREAT KNIVES MANUFACTURE Co., Ltd. All offense against the copyright will be sued by the owner.

FOR EASTMAN



131C1-12
133C1-12



133C1-25



133C1-11



133C1-14

FOR MAIMIN



381A



330N



525

FOR WOLF



12701
12801



12800

FOR SU-LEE



2626-S



2626



262327



© Great Knives Manufacture Co., Ltd.

The trademark and artworks are the intellectual property which is preserved by GREAT KNIVES MANUFACTURE Co., Ltd. All offense against the copyright will be sued by the owner.

FOR NIPPY



416



400/7
T-50
7506-2



513
T-80
7506-1

FOR SUPRENA



M688Z

FOR KM



A-118



S150



R-58

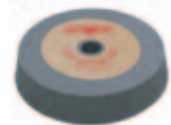

R101J03



R101E08



R101W05



© Great Knives Manufacture Co., Ltd.

The trademark and artworks are the intellectual property which is preserved by GREAT KNIVES MANUFACTURE Co., Ltd. All offense against the copyright will be sued by the owner.

FOR EASTMAN KM



MODEL NO.

- | | |
|------------|------------------|
| GS-181C2-1 | Coarse Grits 80 |
| GS-181C2-2 | Medium Grits 100 |
| GS-181C2-5 | Fine Grits 120 |
| KM EU 100 | Medium Grits 100 |



© Great Knives Manufacture Co., Ltd.

The trademark and artworks are the intellectual property which is preserved by GREAT KNIVES MANUFACTURE Co., Ltd. All offense against the copyright will be sued by the owner.

FOR BAND KNIVES



SIZES

2200x10X0.45
2310x10X0.45
2450x10X0.45
2800x10X0.45
3000x10X0.45
3100x10x0.45
3150x10X0.45
3240x10X0.45
3250x10X0.45
3380x10X0.45

SIZES

3500x10X0.45
3600x10X0.45
3700x10X0.45
3760x10X0.45
3850x10X0.45
3860x10X0.45
3900x10X0.45
3960x10X0.45
4000x10X0.45
4100x10X0.45

SIZES

4120x10X0.45
4200x10X0.45
4290x10X0.45
4500x10X0.45
4555x10X0.45
4745x10X0.45
4920x10X0.45
5030x10X0.45
5300x10X0.45



© Great Knives Manufacture Co., Ltd.

The trademark and artworks are the intellectual property which is preserved by GREAT KNIVES MANUFACTURE Co., Ltd. All offense against the copyright will be sued by the owner.

FOR CLEANING GUN

ccc



PARTS NO	
CG-500(S)110V	
CG-500(S)220V	
CG-500(AJ)110V	
CG-500(AJ)220V	
CG-500(S+AJ)110V	
CG-500(S+AJ)220V	

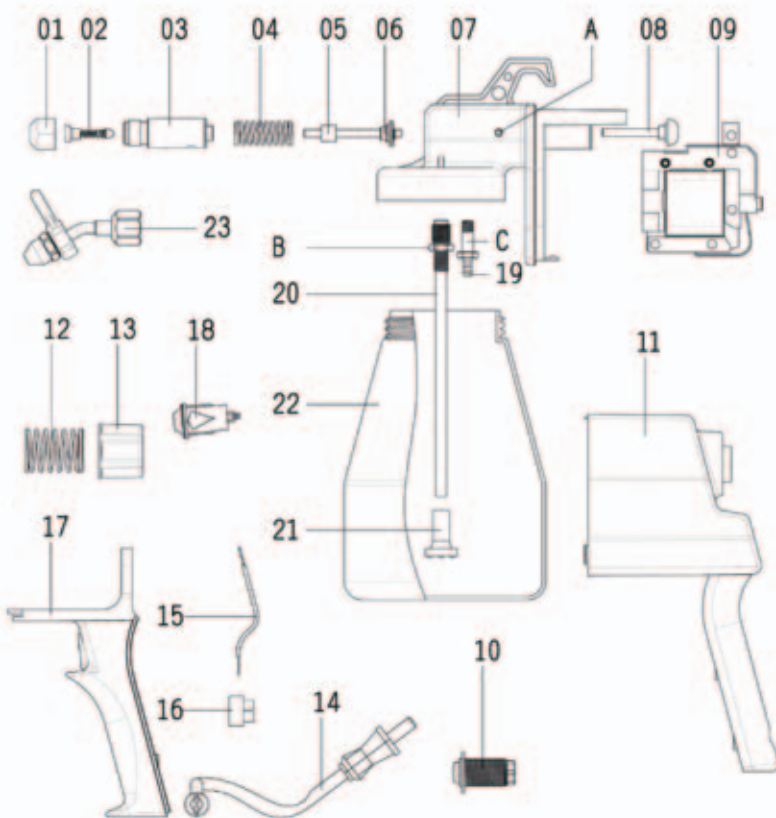

01	Nozzle
02	Spreading plug
03	Cylinder
04	Compression spring
05	Oil absorber
06	Compression rod
07	Front cover
08	Pushing rod
09	Coil set
10	Adjusting screw
11	Top cover
12	Adjusting spring
13	Adjusting knob
14	Power wire
15	Connecting wire
16	Connector
17	Bottom cover
18	Pushbutton
19	Return screw
20	Suction pipe
21	Filter
22	Container
23	Adjustable nozzle



© Great Knives Manufacture Co., Ltd.

The trademark and artworks are the intellectual property which is preserved by GREAT KNIVES MANUFACTURE Co., Ltd. All offense against the copyright will be sued by the owner.



SPARE PARTS FOR CUTTING MACHINE

EASTMAN	100
KM	109



© Great Knives Manufacture Co., Ltd.

The trademark and artworks are the intellectual property which is preserved by
GREAT KNIVES MANUFACTURE Co., Ltd. All offense against
the copyright will be sued by the owner.

FOR

CUTTING MACHINE SPARE PARTS FOR EASTMAN

««

4C1-99	SHARPENER HOLD-DOWN, NUT	54C4-32	WRIST PIN PLUG
4C1-150	SHARPENER HOLD-DOWN, NUT	62C1-140	HANDLE BRACKET
4C1-179	FRONT-TO-REAR BRARING, NUT	71C3-18	FRONT BALL BEARING RETAINER
4C2-2	PLATE BOLT, NUT	73C7-203	OIL TUBE , CLEAR
20C3-38	FRONT TO REAR BEARING, SCREW	73C7-204	OILER TUBE
20C3-39	FRONT TO REAR BEARING, SCREW	85C1-45	CRANK 5 - 1-1/2" STROKE
20C13-96	STANDARD-TO-BEARONG, SCREW	90C6-38	FRONT BALL BEARING
24C4	PLATE, BOLT	91C4-25	RIVET CROSSHEAD
4C1-145	SHAFT, LOCKNUT	191C1-21	CROSS HEAD FELT PAD
4C2-87	CLUTCH ,NUT	191C1-38	WRIST PIN FELT PAD
8C5-10	AUTOMATIC STITCH INSULATION	191C1-42	OIL FELT WICKING, LONG
8C12-4	LEAD WIRE INSULATION	191C1-43	OIL FELT WICKING, SHORT
10C1-41	FAN ROTOR	191C1-45	OIL FELT WICKING .187DIA X .44
12C1-12	LOADING SPRING, WASHER	201C1-11	EYELET
12C1-32	LOCK, WASHER	300C3-2	SCREW
13C1-9	TUNING KNOB	302C8-2	SCREW, FLAT HEAD #4-40 X 3/4
18C6-16	RETAINING RING	302C10-4	SCREW, #6-32 X 5/16 FLAT HEAD
22C1-24	CARRYING HANDLE	307C18-1	SCREW
30C1-8	DUST CAP	308C12-1	SCREW, #8-32 X 3/8 SOCKET HEAD
34C1-51	CLUTCH, SPRING	308C14-1	GUIDE HOLD DOWN SCREW
47C4-79	TERMINAL	309C15-5	GUIDE ADJUSTMENT SCREW
47C4-80	TERMINAL	525C1-5	L.H. & R.H. GUIDES 1-1/2 STROKE
53C7-35	FAN COVER	531C1-53	OPERATING HANDLE
73C7-121	TERMINAL WIRE TUBING	579C2-17	CROSS HEAD (W/ WRIST,PIN,WASHER,BOLT)
90C1-146	REAR BEARING HOUSING	580C1-198	SWITCH-SINGLE-SPEED-1&3-PHASE
90C6-46	REAR BALL BEARING	607C1-35	OILING DEVICE
254C1	CABLE TIE 4"	664C1-4	CONNECTING ROD 1 1/2 STROKE
300C12-6	SCREW, ROUND HEAD	706C1-4	CAPACITOR 629 110V
301C8-1	SCREW, #4-40 X 1/2 FILLISTER HEAD	706C1-5	CAPACITOR 629 220V
301C12-3	SCREW, #8-32 X 3/8 FILLISTER HEAD	4C1-149	NUT, ELASTIC
305C8-1	SCREW,BINDING HEAD	4C1-161	NUT, SELF LOCK
305C10-1	SCREW,BINDING HEAD	4C2-112	L.H. NUT FOR SCREW SHAFT
597C2-15	CUTOUT ASSY 50 CYCLE 3000RPM	4C2-113	R.H. NUT FOR SCREW SHAFT
783C1-3	GROUNDING WIRE ASSY	5C5-16	COLLAR, LOWER
4C1-111	OPEARING HANDLE LOCK NUT	11C12-54	SHAFT FOR CAM
4C1-132	CRANK BELL BEARING LOCK NUT	12C15-57	SPRING WASHER FOR RELEASE LEVER
4C1-190	LOCK NUT FOR SHAFT	12C15-69	WASHER FOR LOCK BRACKET
4C2-91	NUT FOR GUIDE SCREW	12C15-74	WASHER, FLAT
4C2-110	STOP NUT	12C15-91	THRUST WASHER, UPPER NUT
4C3-8	GUIDE ADJUSTMENT NUT	17C15-106	ROLL PIN FOR COLLAR
11C12-92	SHAFT FOR BALL BEARING	20C4-17	PRESSURE FOOT LEVER SCREW
12C1-21	SHAKEPROOF WASHER	20C12-13	CAM SHAFT SPRING SCREW
12C1-24	KNIFE LOCK WASHER	20C12-113	SCREW FOR LATCH
12C10-2	WASHER	20C12-117	SCREW FOR PRESSURE FOOT SHOE
12C15-14	GUIDE WASHER	20C12-156	SCREW FOR RELEASE LEVER
12C15-53	CONNECTING ROD WASHER	20C12-137	SCREW FOR KNIFE GUARD LOCK
15C13-23	STUD,UPPER	22C3-2	LIFT HANDLE FOR KNIFE GUARD LOCK
15C13-34	STUD, LOWER L.H. MOUNTING	34C1-20	TENSION SPRING
15C13-39	STUD, LOWER R.H. MOUNTING	34C8-12	SPRING FOR PRESSURE FOOT LOCK
17C4-6	WRIST PIN	34C10-179	SPRING FOR PRESSURE FOOT LEVER
18C6-79	LOCK RING	34C10-107	SPRING FOR LATCH
18C6-80	O-RING	53C11-72	COVER FOR CAM
20C5-17	CONNECTING ROD CLAMP SCREW	53C11-103	VINYL COVER FOR HANDLE
20C12-62	FRONT HOUSING PLUG SCREW	55C4-49	SPACER FOR KNIFE GUARD LOCK BRACKET
20C12-79	SCREW FOR HANDLE BRACKET	68C1-192	PRESSURE FOOT SHOE, ALL STROKES
24C1-3	KNIFE LOCK BOLT	71C3-15	THRUST BALL BEARING
34C10-142	SPRING FOR CAPACITOR	86C7-34	CAP FOR TUBE
52C5-235	SWITCH PLATE (SINGLE-SPEED)	90C4-47	BEARING FOR CAM SHAFT
53C6-2	OILER TUBE COVER	97C3-35	LATCH FOR CAM
53C11-91	CAPACITOR COVER	147C1-26	EXTENSION FOR SCREW SHAFT



© Great Knives Manufacture Co., Ltd.

The trademark and artworks are the intellectual property which is preserved by
GREAT KNIVES MANUFACTURE Co., Ltd. All offense against
the copyright will be sued by the owner.

FOR CUTTING MACHINE SPARE PARTS FOR EASTMAN

171C1-16	LOCK (ONLY) FOR PRESSURE FOOT	584C3-16	BELLCRANK COMPLETE WITH LEVER
300C10-1	SCREW, #6-32 X 3/16 ROUND HEAD	602C1-9	DRIVER PULLEY WITH DRIVER
300C10-4	SCREW, #6-32 X 3/8 ROUND HEAD	627C1-10	IDLER GEAR & BUSHING
302C10-8	SCREW, #6-32 X 3/4 FLAT HEAD	716C1-12	DRIVER SHAFT WITH GEAR
309C15-7	SET SCREW FOR CAM	727C1-6	OIL PAD & HOLDER
553C1-7	PRESSURE FOOT LOCK BRACKET COMPLETE	17C15-82	RIVET
553C1-8	PRESSURE FOOT LOCK BRACKET ONLY	300C7-2	SCREW, #4-36 X 3/16 ROUND HEAD
605C1-36	PRESSURE FOOT ROD 7"-8" KNIFE	1C13-13	NUT
605C1-37	PRESSURE FOOT ROD 9"-10" KNIFE	53C11-109	VINYL COVER FOR CRANK
621C1-7	RELEASE LEVER WITH CAM	4C1-189	JAM NUT,#8-32
683C1-17	PRESSURE FOOT LEVER	4C2-63	NUT FOR SHARPENER SHOE SCREW
713C4-4	SCREW SHAFT W/EXTENSION R&H HEAD	12C15-93	WASHER, SHOE
713C4-5	NUTS 5-8"(713C-4)/NUTS 9-10"(713C-5)	20C6-25	ADJUSTING SCREW
732C1-11	SHARPENER HOUSING W/BUSHING TUBES ONLY	20C12-143	SCREW FOR CLAMPING ARM
732C1-12	5"-8" KNIFE(732C1-11) / 9"-10" KNIFE(732C1-12)	20C12-153	SCREW FOR SHARPENER SHOE
65C1-77	ROD FOR PRESS FOOT 5"-8"	21C14-14	BUSHING FOR SHARPENER SHOE
65C1-75	ROD FOR PRESS FOOT 9"&10"	34C10-45	SPRING FOR PULLEY SLIDE
11C12-95	SCREW SHAFT ONLY 5" - 8"	34C10-123	SPRING FOR ARM
11C12-96	SCREW SHAFT ONLY 9" -10"	34C10-148	L.H. SHARPENER SHOE SPRING
4C2-85	R.H. FOLLOWER NUT	34C10-149	R.H. SHARPENER SHOE SPRING
4C2-86	L.H. FOLLOWER NUT	35C7-28	CLAMPING ARM FOR SHOE
11C12-58	R.H. SQUARE SHAFT 5"-8" KNIFE	53C4-78	GEAR COVER
11C12-59	R.H. SQUARE SHAFT 9"-10" KNIFE	54C4-35	OIL HOLE PLUG
11C12-56	L.H. SQUARE SHAFT 5"-8" KNIFE	62C6-31	BRACKET, LOWER GEAR
11C12-57	L.H. SQUARE SHAFT 9"-10" KNIFE	70C4-32	GUIDE BACK OF STANDARD
11C12-64	SHAFT FOR CRANK	79C12-219	WEAR PLATE
12C11-74	THRUST WASHER	87C3-50	GEAR ON SCREW SHAFT
12C15-29	THRUST WASHER	87C5-13	INTERMEDIATE GEAR
12C15-30	THRUST WASHER FOR BOTTOM PLATE	90C4-51	BEARING FOR SCREW SHAFT
17C15-78	PIN FOR BELL CRANK	90C4-59	BEARING FOR SHAFT EXTENSION
17C15-103	ROLL PIN FOR PUSH ROD	147C1-28	R.H. SHAFT EXTENSION
17C15-113	SPREADER PIN	147C1-29	L.H. SHAFT EXTENSION
18C6-81	RETAINING RING FOR SHAFT	152C1-19	FRONT PULLEY FOR BELT
18C6-26	RETAINING RING FOR BELL CRANK	209C1	NEOPRENE BAND FOR PULLY
34C10-89	SPRING FOR BELL CRANK	300C7-3	SCREW, #4-36 X 1/4 ROUND HEAD
55C4-41	SPACER BELL CRANK	300C10-2	SCREW, #6-32 X 1/4 ROUND HEAD
62C16-151	SHARPENER HOUSING (ONLY)	300C10-6	SCREW, #6-32 X 1/2 ROUND HEAD
65C6-75	PUSH ROD	301C7-2	SCREW, #4-36 X 3/16 FILLISTER HEAD
71C1-10	OIL RETAINER-IDLER GEAR	301C10-3	SCREW, #6-32 X 3/8 FILLISTER HEAD
73C7-46	TUBE FOR SQUARE SHAFT 5"-8" KNIFE	309C12-2	STOP SCREW, L.H. SHOE
73C7-47	TUBE FOR SQUARE SHAFT 9"-10" KNIFE	712C1	R.H. SLIDE WITH PULLEY
73C7-48	TUBE FOR SCREW SHAFT 5"-8" KNIFE	712C1-1	L.H. SLIDE WITH PULLEY
73C7-49	TUBE FOR SCREW SHAFT 9"-10" KNIFE	715C1-19	LOWER GEAR BRACKET WITH COVER, SCREW PLATE 5-13"
79C12-163	BOTTOM PLATE, SHARPENER HOUSING	715C1-23	LOWER GEAR BRACKET (COMPLETE)
85C3-6	CRANK BELL (ONLY)	728C1-5	STABILIZER ASSEMBLY
87C3-8	SPIRAL GEAR	743C1-28	R.H. PRE-SET SHARPENER SHOE (ONLY)
87C3-44	SPUR GEAR	743C1-29	L.H. PRE-SET SHARPENER SHOE (ONLY)
87C3-53	GEAR AND SHAFT	820C1-7	L.H. COMPLETE SHOE ASSEMBLY,
90C4-29	BEARING FOR DRIVE SHAFT (LOWER)	820C1-8	R.H. COMPLETE SHOE ASSEMBLY,
90C4-33	BEARING FOR GEAR	12C1-35	LOCK WASHER, #8
90C4-34	BEARING FOR BELL CRANK	17C1-4	TAPER PIN #0 X 3/4
90C4-42	BEARING FOR DRIVE SHAFT	17C6-9	HINGE PIN
90C4-48	BEARING FOR DRIVE SHAFT (UPPER)	20C5-12	CLAMP SCREW FOR ROLLERS
90C4-58	BEARING FOR SCREW SHAFT	20C12-19	KNIFE SLIDE SCREW
90C6-24	BALL BEARING FOR CRANK	20C13-51	HINGE PIN CLAMP SCREW
142C1-7	KEY FOR GEAR.	34C1-57	PLATE WING TENSION SPRING
300C7-1	SCREW, #4-36 X 1/8 ROUND HEAD	60C1-55	PLATE WING (FOR SMALL PLATES)
302C10-6	SCREW, #6-32 X 1/2 FLAT HEAD	60C1-56	PLATE WING (FOR LARGE PLATES)
302C12-3	SCREW, #8-32 X 3/8 FLAT HEAD	79C4-12	THROAT PLATE WITH SCREW AND PIN
584C2-3	BELLCRANK WITH PIN & BEARING(ONLY)	79C4-24	TAPERED & RELIEVED THROAT PLATE ASSEMBLY



© Great Knives Manufacturing Co., Ltd.

 The trademark and artworks are the intellectual property which is preserved by
GREAT KNIVES MANUFACTURE Co., Ltd. All offense against
 the copyright will be sued by the owner.

<<SPARE PARTS

-101-

FOR CUTTING MACHINE SPARE PARTS FOR EASTMAN

213C1-1	FIBRE SHIM
505C3-223	SMALL PLATE BASE COMPLETE 5"-8" KNIFE
505C3-224	LARGE PLATE BASE COMPLETE 9"-13" KNIFE
528C1-116	STANDARD (COMPLETE W/SLIDER, THROAT PLATE)
528C1-121	10" KNIFE (528C1-116) / 8" KNIFE (528C1-121)
532C2-5	RUBBER MOUNTED ROLLER (COMPLETE)
619C1-31	ROLLER SHELL (COMPLETE)
643C1-43	KNIFE SLIDE (COMPLETE WITH SCREWS) 8"
643C1-47	KNIFE SLIDE (COMPLETE WITH SCREWS) 10"
529C1-8	KNIFE BOLT WRENCH
95C5-3	ALLEN WRENCH FOR SHOE SET SCREW
242C2-2	BEARING GREASE
162C2	OIL CAN
81C1-2	SLOT CLEANSE
181C2-2 SP	ABRASINE BELTS
508C1-100	TREMINAL BLOCK
523C1-100	ATTACHMENT PLUG

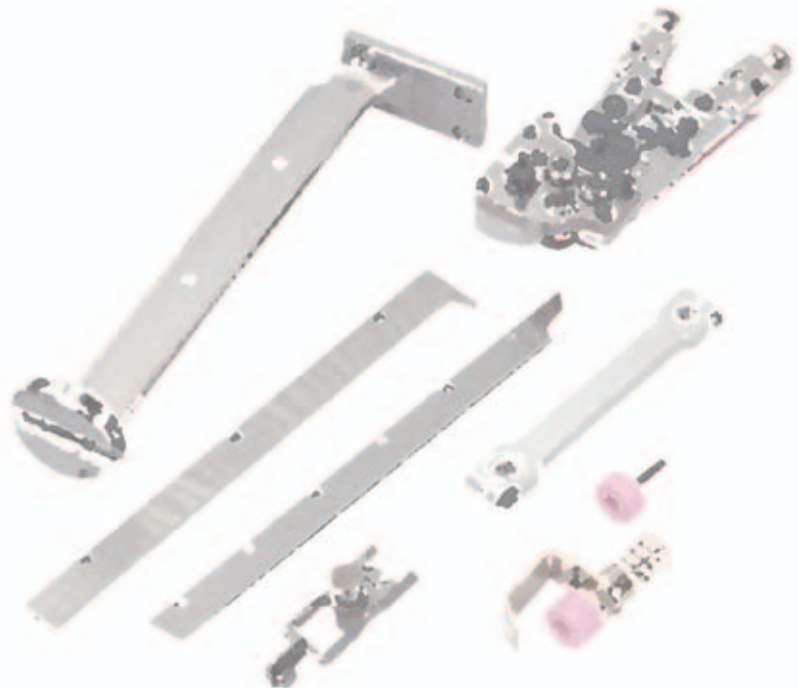

© Great Knives Manufacture Co., Ltd.

The trademark and artworks are the intellectual property which is preserved by GREAT KNIVES MANUFACTURE Co., Ltd. All offense against the copyright will be sued by the owner.

FOR CUTTING MACHINE SPARE PARTS FOR EARTMAN

Single-Phase Motor Assemblies

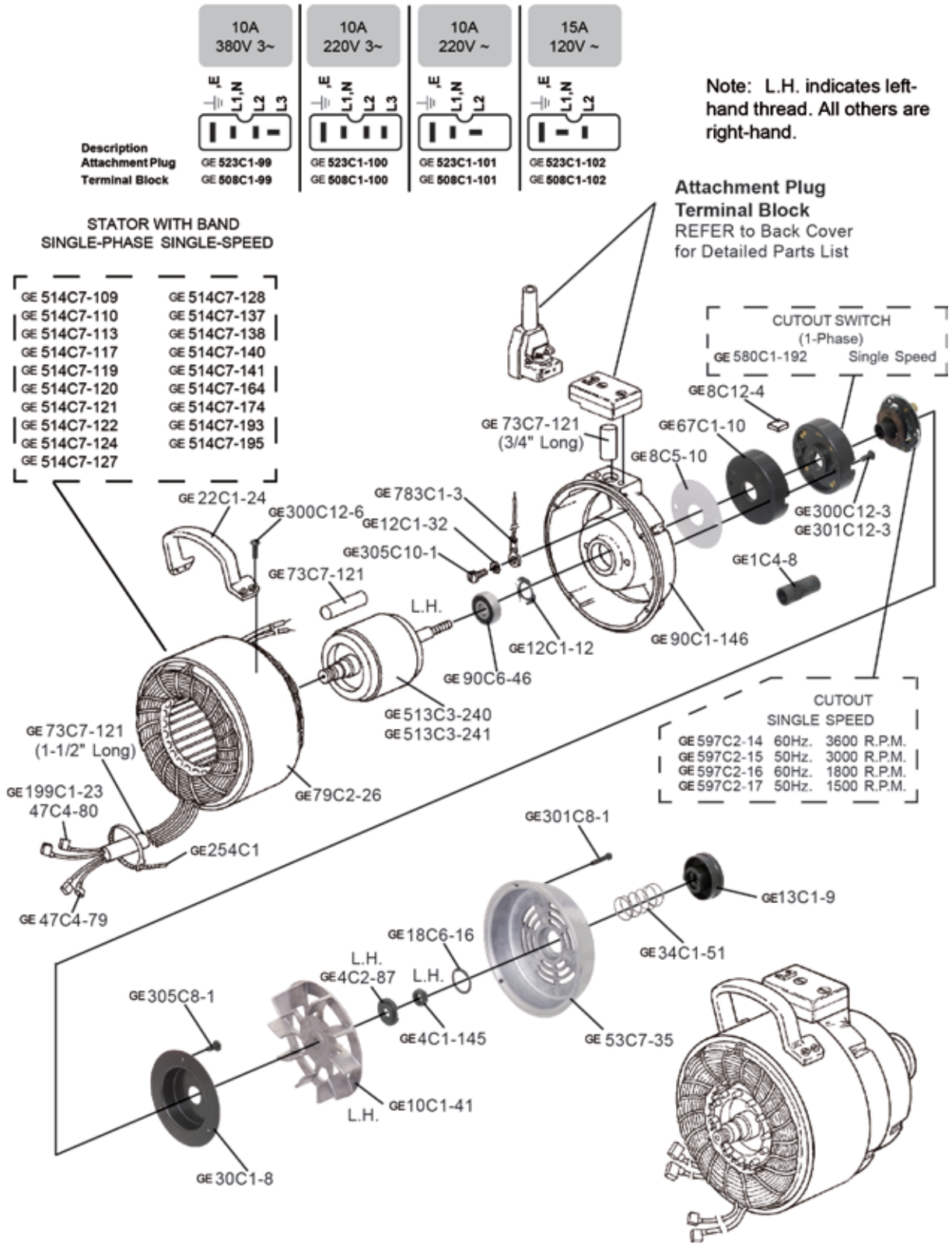

© Great Knives Manufacture Co., Ltd.

The trademark and artworks are the intellectual property which is preserved by GREAT KNIVES MANUFACTURE Co., Ltd. All offense against the copyright will be sued by the owner.

FOR CUTTING MACHINE SPARE PARTS FOR EARTMAN

Front Bearing Housing with Oiler Assembly

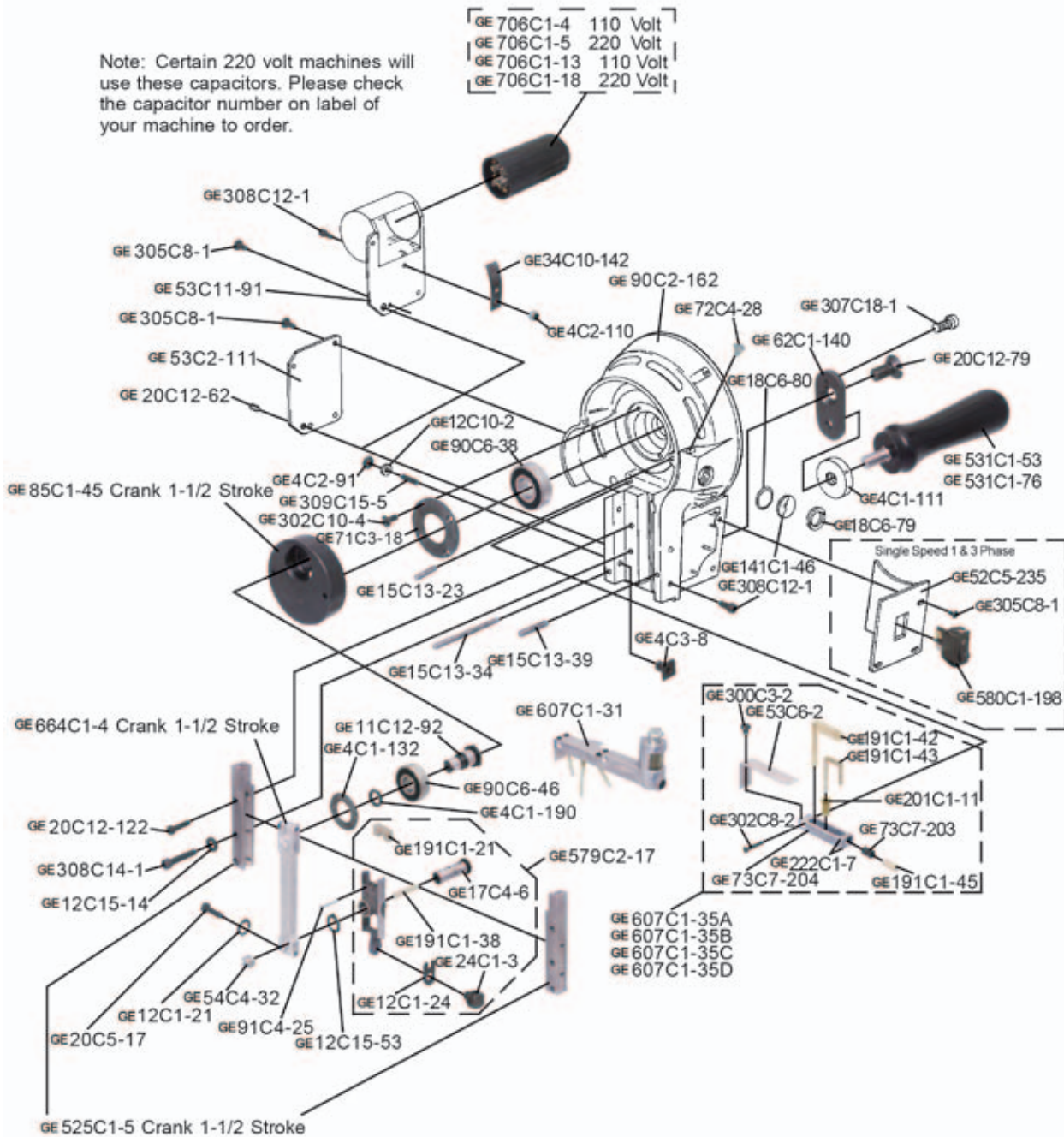

Notes: L.H. indicates left-hand thread. All others are right-hand.

Slip large lug over switch before replacing switch base. Secure switch to base tightly to ensure positive ground.



© Great Knives Manufacture Co., Ltd.

The trademark and artworks are the intellectual property which is preserved by GREAT KNIVES MANUFACTURE Co., Ltd. All offense against the copyright will be sued by the owner.

FOR CUTTING MACHINE SPARE PARTS FOR EARTMAN

Sharpener Housing Assembly

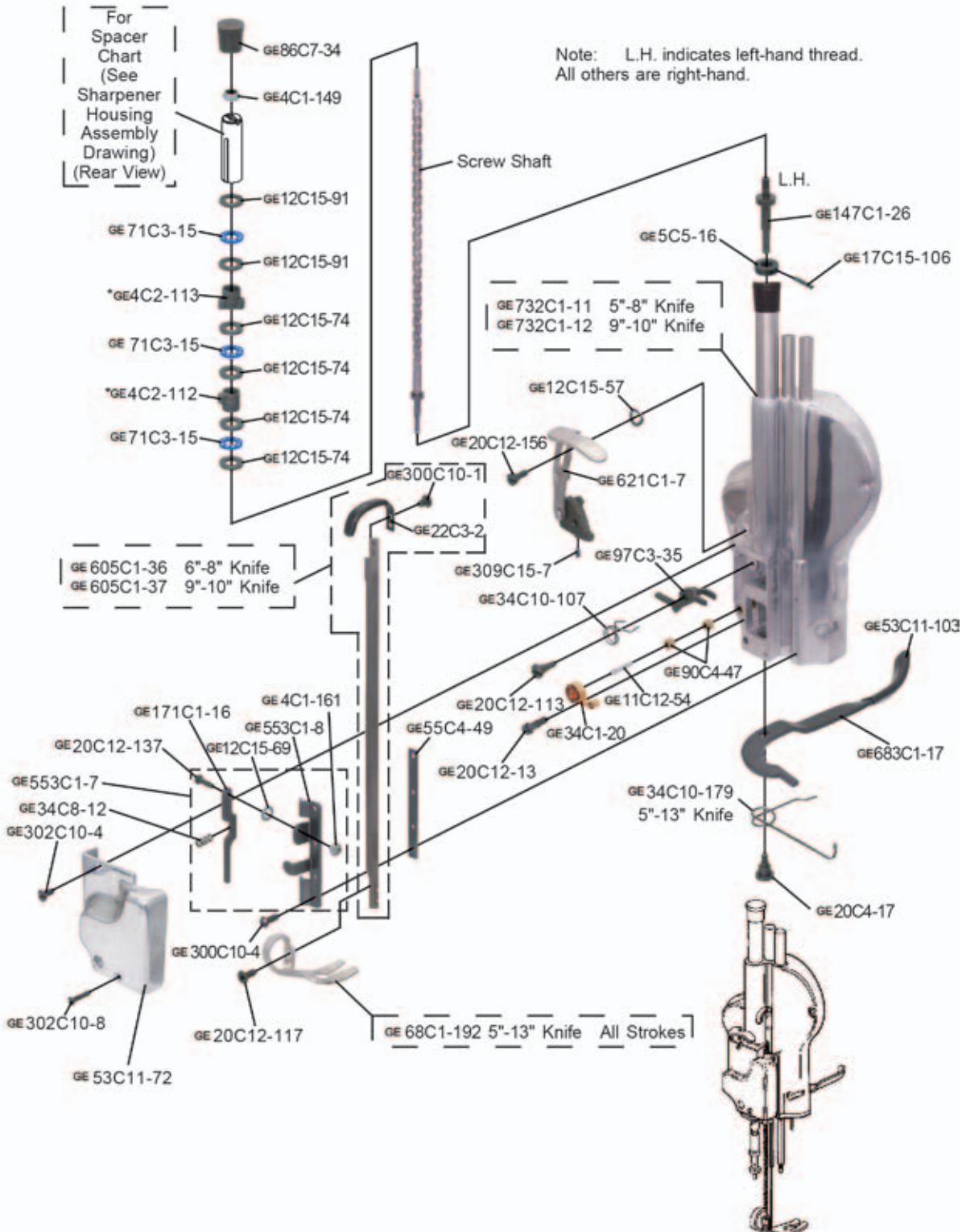

© Great Knives Manufacture Co., Ltd.

The trademark and artworks are the intellectual property which is preserved by GREAT KNIVES MANUFACTURE Co., Ltd. All offense against the copyright will be sued by the owner.

FOR CUTTING MACHINE SPARE PARTS FOR EARTMAN

Sharpener Housing Assembly

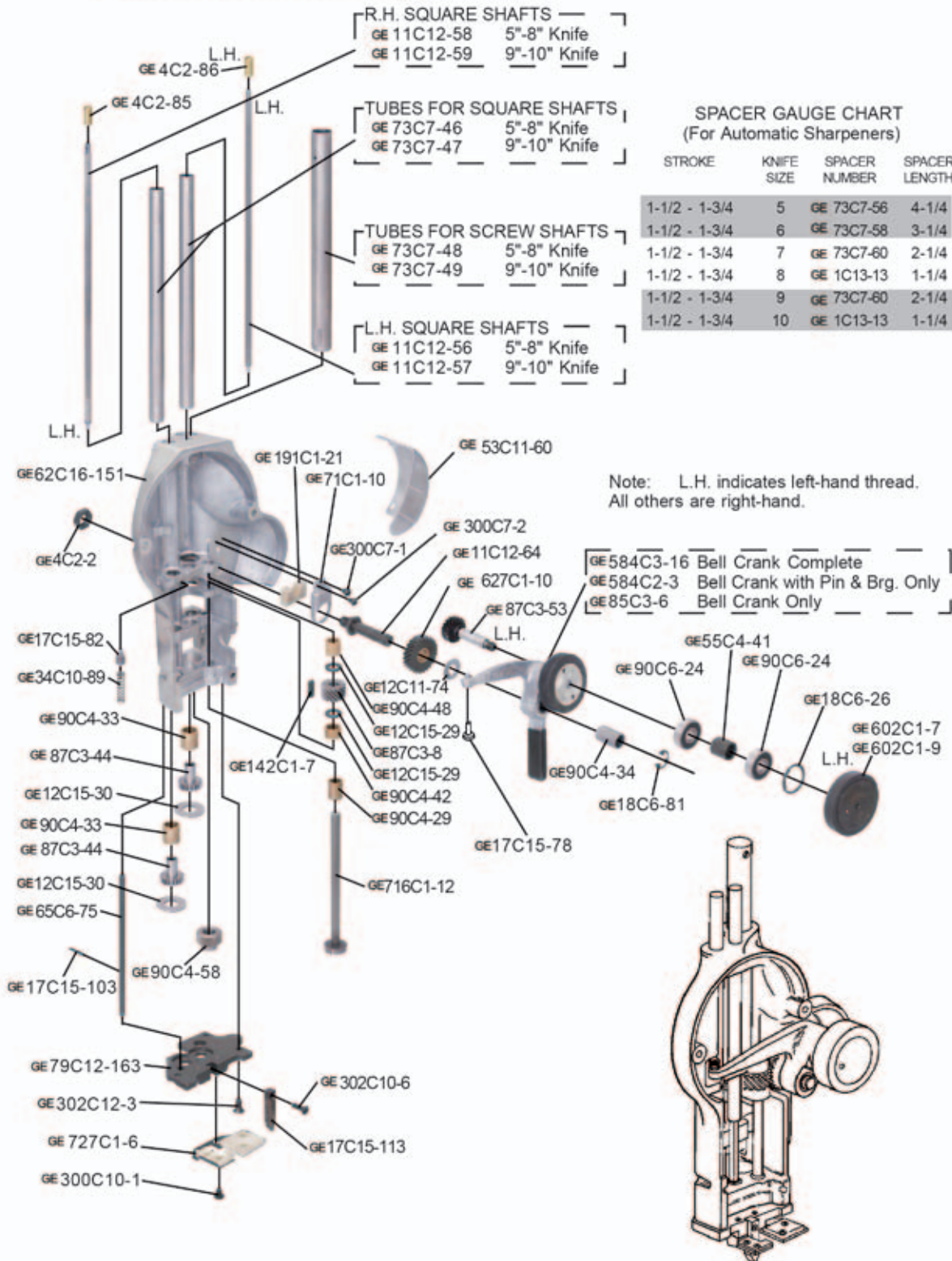

© Great Knives Manufacture Co., Ltd.

The trademark and artworks are the intellectual property which is preserved by GREAT KNIVES MANUFACTURE Co., Ltd. All offense against the copyright will be sued by the owner.

FOR CUTTING MACHINE SPARE PARTS FOR EARTMAN

Lower Gear Bracket Assembly

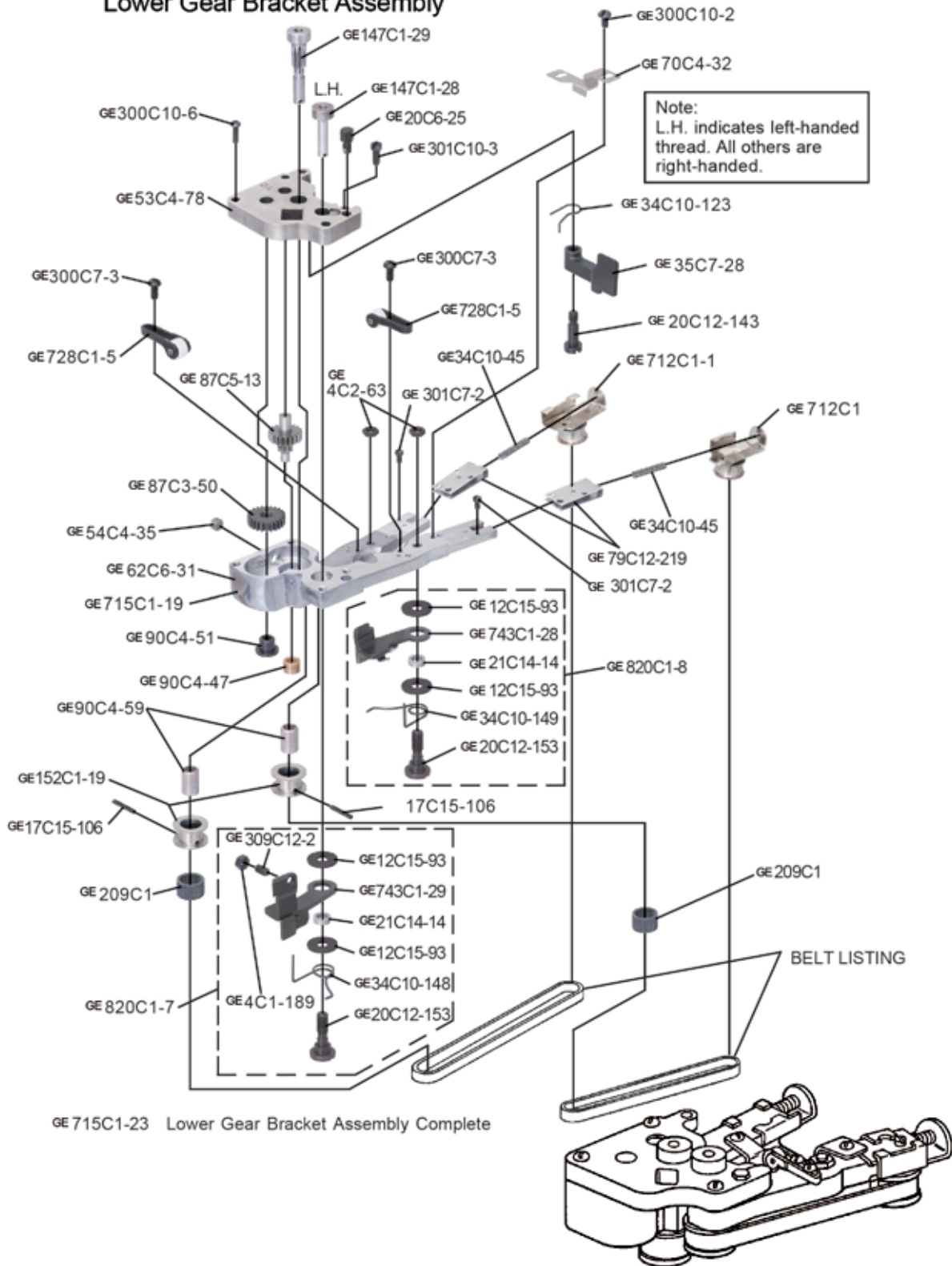

© Great Knives Manufacture Co., Ltd.

The trademark and artworks are the intellectual property which is preserved by GREAT KNIVES MANUFACTURE Co., Ltd. All offense against the copyright will be sued by the owner.

FOR CUTTING MACHINE SPARE PARTS FOR EARTMAN

Standard and Baseplate Assembly

STANDARDS COMPLETE W/SLIDES	
GE528C1-121	8" Standard
GE528C1-116	10" Standard

KNIFE SLIDES	
GE643C1-43	8" Knife
GE643C1-47	10" Knife

INSTRUCTIONS FOR REMOVING WORN PLATE ROLLER SHELL

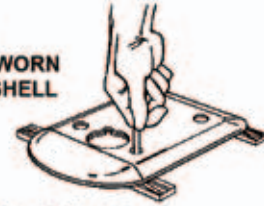

Removing a Worn Plate Roller Shell

NOTE: A roller shell (complete with shaft and bearings) may be ordered as required. Specify part number GE619C1-30.

To install a new roller shell, invert the baseplate and press the roller shell into the ring assembly.

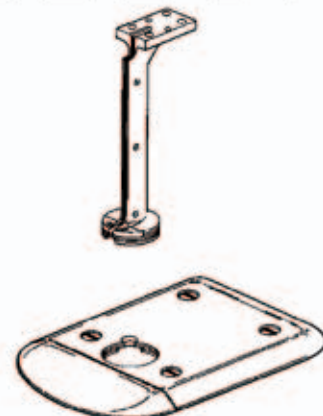
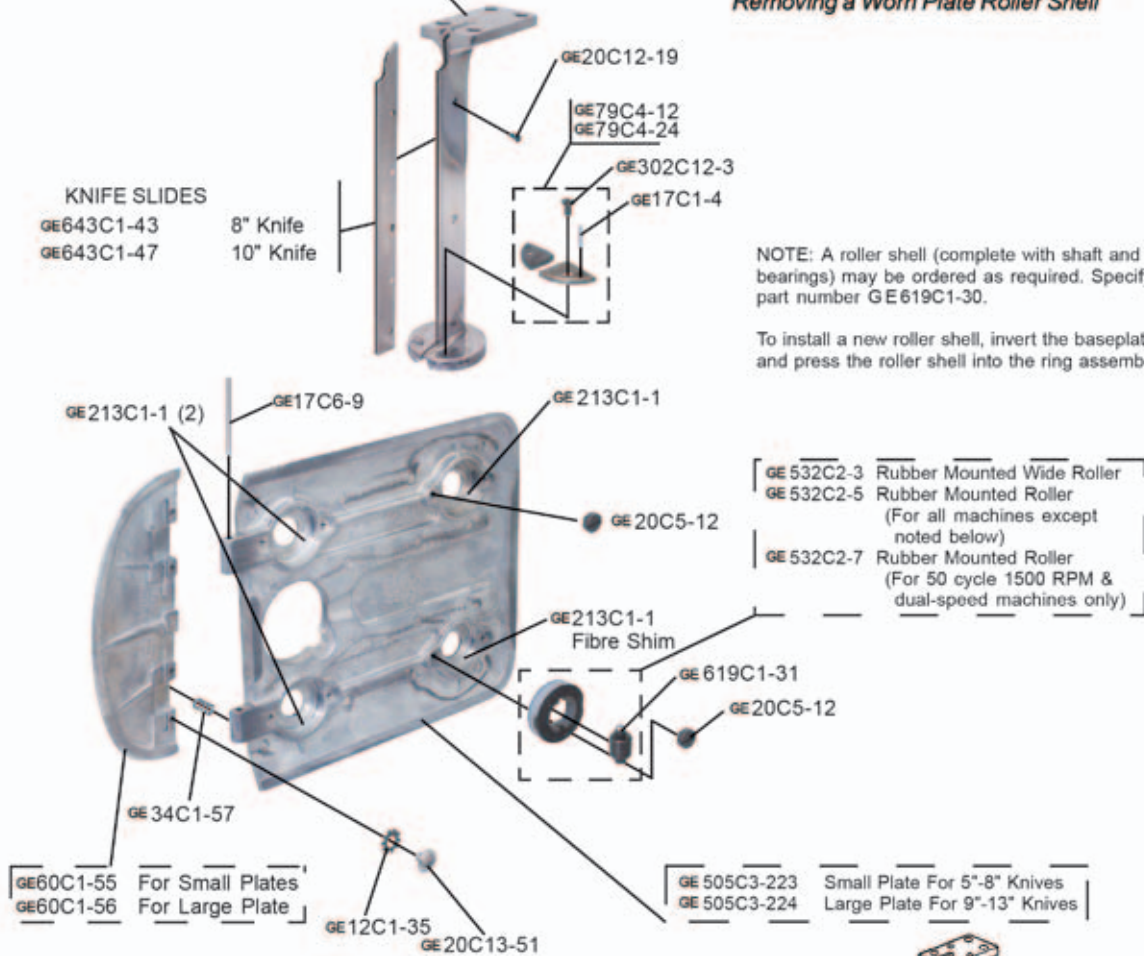

© Great Knives Manufacture Co., Ltd.

The trademark and artworks are the intellectual property which is preserved by GREAT KNIVES MANUFACTURE Co., Ltd. All offense against the copyright will be sued by the owner.

FOR CUTTING MACHINE SPARE PARTS FOR KM

GE-M-1	Capacitor-Stator	GE-M-66	Ground Clip
GE-M-2	Carrying Handle Screws	GE-M-67	Attachment Plug Complete(3P)
GE-M-3	Rotor Fan	GE-M-68	Terminal Block Complete(3P)
GE-M-4	Rotor With Shaft	GE-M-69	Attachment Plug (Complete)
GE-M-6	Dust Cap Screw	GE-M-70	Terminal Block (Complete)
GE-M-7	Rear Bearing Housing	GE-M-71	Terminal Sleeve
GE-M-8	Dust Cap	GE-M-72	Terminal Contact with Pin
GE-M-9	Turning Knob	GE-M-73	Operating Handle
GE-M-13	Front to Rear Bearing Nut	GE-M-74	Lock Nut
GE-M-14	Front to Rear Bearing Screw	GE-M-75	Switch Cover Screw
GE-M-20	Switch	GE-M-76	Switch Cover
GE-M-21	Clutch Spring	GE-M-77S	GKM-AU-J-077S
GE-M-22	Retaining Ring	GE-M-77L	GKM-AU-J-077L
GE-M-23	Rear Ball Bearing	GE-M-78	Plate Complete
GE-M-24	Spring Washer	GE-M-80	Rubber Mounted Roler
GE-M-25	Clutch Nut	GE-M-80C	Roller
GE-M-26	Shaft Lock Nut	GE-M-80R	Rubber
GE-M-27	Crank	GE-M-81	Hinge Pin Short
GE-M-28	Crank Ball Bearing	GE-M-82	Hinge Pin Clamp Screw
GE-M-29	Crank Ball Bearing Lock Nut	GE-M-83	Plate Wing Tension Spring
GE-M-30	Screw for Brg Shaft	GE-M-84	Knife Slide Screw
GE-M-31	Shaft for Ball Bearing	GE-M-85	Standard(8")
GE-M-32	Oil Pad Holder	GE-M-85	Standard(10")
GE-M-33	Oil Felt	GE-M-85	Standard(13")
GE-M-34	Oil Tank	GE-M-85	Standard(6")
GE-M-34C	Set Oil Tank	GE-M-85	Standard(7")
GE-M-35	Oil Tank Cap	GE-M-86	Knife Slide(8")
GE-M-36	Connec ting Rod	GE-M-086	Knife Slide(10")
GE-M-37	Shakeproof Washer	GE-M-87	Screw for Throat Plate
GE-M-38	Connec Ting Rod Clamp Screw	GE-M-88	Throat Plate
GE-M-39	Wrist Pin	GE-M-89	Lock Washer
GE-M-40	Wrist Pin Plug	GE-M-90-S	Plate Screw
GE-M-41	Knife Lock Washer	GE-M-90-N	Plate Nut
GE-M-42	Nuts for Guide Screw	GE-M-92	Cap for Tube
GE-M-43	Guide Washer	GE-M-93	Driving Shaft(6"~8")
GE-M-44	Connecting Rod Washer	GE-M-93	Driving Shaft(9"~10")
GE-M-45	Guide Adjusting Screw	GE-M-93	Driving Shaft(13")
GE-M-46	Guide Adjusting Nut	GE-M-94	Hand Follower(6"~8")
GE-M-47	Guide Lock Screw	GE-M-94	Hand Follower(9"~10")
GE-M-48	R.H.Guide	GE-M-94	Hand Follower(13")
GE-M-49	L.H.Guide	GE-M-96	Screw for Latch
GE-M-48/49	Guide	GE-M-97	Shaft for Cam
GE-M-50	Cross Head	GE-M-98	Cam Shaft Spring Screw
GE-M-51	Knife Lock Bolt	GE-M-99	Pres Foot Lock Bracket Screw
GE-M-52	Terminal Block Screw	GE-M-100-S	Screw for Cover(S)
GE-M-53	Ground Clip Screw	GE-M-100-L	Screw for Cover(L)
GE-M-54	Set Screw	GE-M-101	Cover Over Cam
GE-M-55	Front Bearing Housing	GE-M-102	Collar for Screw Shaft
GE-M-56	Sharpener Hold Down Screw	GE-M-104-R	Nut for Screw ShaftR.H
GE-M-57	Retainer Screw	GE-M-104-L	Nut for Screw Shaft L.H
GE-M-58	Oil Pad Holder Screw	GE-M-105	Washer for Screw Shaft L.H
GE-M-59-S	Guide Hold Down Screw(S)	GE-M-106	Screw shaft (6"~8")
GE-M-59-L	Guide Hold Down Screw(L)	GE-M-106	Screw shaft (9" ~ 10")
GE-M-60	Lower Sharpener	GE-M-106	Screw shaft(13")
GE-M-60-R	Hold down Nut R	GE-M-107	Spacer tube(6")
GE-M-61L	Stud Lower L.H.Mountaing(L)	GE-M-107	Spacer tube(7" ~ 13")
GE-M-61R	Stud Lower L.H.Mountaing(R)	GE-M-107	Spacer tube(8" ~ 9" ~ 10")
GE-M-63	Standard-to-Bearing Screw	GE-M-108	Stop Nut for Screw Shaft
GE-M-64	Front Ball Bearing	GE-M-109	Spring for Pressure Foot Lock
GE-M-65	Front Ball Bearing Retainer	GE-M-110	Spring for Lateh



© Great Knives Manufacture Co., Ltd.

The trademark and artworks are the intellectual property which is preserved by
GREAT KNIVES MANUFACTURE Co., Ltd. All offense against
the copyright will be sued by the owner.

<<SPARE PARTS

-109-

FOR CUTTING MACHINE SPARE PARTS FOR KM

GE-M-111	Cam Spring	GE-M-154	Washer for Crank Shaft
GE-M-112	Pressure Foot Rod(6")	GE-M-155	Lock Ring for Ball Bearing
GE-M-112	Pressure Foot Rod(7")	GE-M-156	Idler Gear With Bushing
GE-M-112	Pressure Foot Rod(8")	GE-M-156-1	Bushing of Idler Gear
GE-M-112	Pressure Foot Rod(10")	GE-M-157	L.H.Spiral Gear With Key
GE-M-112	Pressure Foot Rod(13")	GE-M-158	Screw for Gear Cover
GE-M-113	Screw for Pressure Foot Shoe	GE-M-159	Screw for Gear Cover
GE-M-114	Pressure Foot Lever	GE-M-160	Grease Plug
GE-M-115	Pressure Foot Lever Screw	GE-M-161	Screw for Stabilizer
GE-M-116	Spring for Pressure Foot Lever	GE-M-162	Lower Gear Bracket
GE-M-117	Set Screw for Cam	GE-M-162-M	Lower gear bracke
GE-M-118-C	Cam	GE-M-163	Screw for Slide Pulley
GE-M-118-L	Release Lever	GE-M-164	Lower Gear Bracker Gear Cover
GE-M-118-S	Screw for cam	GE-M-165-N	Adjusting Nut
GE-M-119-S	Lock Screw for Releasr Lever	GE-M-165-S	Adjusting Screw
GE-M-119-SW	Spring Washer	GE-M-166	Gear on Screw Shaft
GE-M-119-W	Washer	GE-M-167	Intermediate Gear
GE-M-120	Lock(only) Pressure Foot	GE-M-168	Bushing for shoe
GE-M-121-S	Screw for Pres Ft Lock	GE-M-169	GKM-AU-J-169
GE-M-121-N	Nut for Pres Ft Lock	GE-M-170	GKM-AU-J-170
GE-M-122	Pressure Foot Lock Bracket	GE-M-171	Set Screw for Sharpener Shoe
GE-M-123	Slide for Pressure Foot Rod	GE-M-172	Stabilizer
GE-M-123-2	Washer Slide for presser foot	GE-M-173	Standard Guide(6"~7")
GE-M-124	Latch for Cam	GE-M-173	Standard Guide(8"~10")
GE-M-125	Pressure Foot Shoe	GE-M-175	Screw for Guide Back
GE-M-126	Spring for Bell Crank	GE-M-176	R.H.Slide With Pulley
GE-M-127	Sharpener Housing(8")	GE-M-177	L.H.Slide With Pulley
GE-M-127	Sharpener Housing(13")	GE-M-178	Neoprene Band
GE-M-128	Bottom Plate Screw	GE-M-179	Front Pulley for Belt
GE-M-129	Bottom Plate	GE-M-180	Roll Pin for Pulley
GE-M-130	Oil Pad & Holder	GE-M-181	Spring for Pulley Slide
GE-M-131	Screw for Oil Pad	GE-M-182	Screw for Clamping Rrm
GE-M-132	Bell Crank With Pim & Bushing	GE-M-183	Clamping Arm for Shoe
GE-M-133	Screw for Cover	GE-M-184	Nut for Sharpener Shoe Screw
GE-M-134	Cover for Driver	GE-M-185	Screw for Sharpener Shoe
GE-M-135	Right Hand Follower Nut	GE-M-186-R	R.H.Sharpener Shoe Spring
GE-M-136	R.H.Square Shaft(6"~8")	GE-M-187-L	L.H.Sharpener Shoe Spring
GE-M-136	R.H.Square Shaft(9" ~ 10")	GE-M-188	Spring for Arm
GE-M-136	R.H.Square Shaft(13")	GE-M-189	Abrasive Belts
GE-M-136-S	R.H.Square Shaft Screw	GE-M-190	Electric Corde Complete
GE-M-137	Left Hand Follower Nut	GE-M-191	Knife
GE-M-138	L.H.Square Shaft(6"~8")	GE-M-192	Knock pin for Throat Plate
GE-M-138	L.H.Square Shaft(9" ~ 10")	GE-M-194	Knife Bolt Wrench
GE-M-138	L.H.Square Shaft(13")	GE-M-195	Screw Driver
GE-M-138-7		GE-M-198	Bearing Grease
GE-M-138-W	L.H.Square Shaft Washer	GE-M-199	Oiler
GE-M-139	Push Rod	GE-M-203	Carrying Handle
GE-M-140	Roll Pin for Push Rod	GE-M-204	Capacitor Cover
GE-M-141	Driver Shaft With Gear	GE-M-205	Screw for Capacitor Cover
GE-M-142	Screw for Spreader Pin	GE-M-206	Capacitor
GE-M-143	Spreader Pin	GE-M-206P	Felt
GE-M-144	Gear & Shaft	GE-M-208	Oil Tank Pile
GE-M-145	Bearing for Gear	GE-M-209	Vinyl Tube
GE-M-146	Driver Pulley(Set)	GE-M-229	Thrust Ball Bearing
GE-M-148	Spur Gear	GE-M-230	Knob for Pressure Foot Rod
GE-M-149	Ball Bearing for Crank	GE-M-231	Screw for Knob
GE-M-150	Retaining Ring	GE-M-232	Oiling Felt for Ldlter Gear
GE-M-151	Thrust Washers for Spiral Gear	GE-M-233	Set Screw for Oiling Felt
GE-M-152	Lock Nut for Crank Shaft	GE-M-301	Automatic Cut-Out Switch
GE-M-153	Shaft for Crank	GE-M-302	Automatic Cut-Out



© Great Knives Manufacture Co., Ltd.

The trademark and artworks are the intellectual property which is preserved by GREAT KNIVES MANUFACTURE Co., Ltd. All offense against the copyright will be sued by the owner.

FOR CUTTING MACHINE SPARE PARTS FOR KM

GE-M-303	Insulated Plate
GE-M-304	Set Screw
GE-M-305	Spring Washer

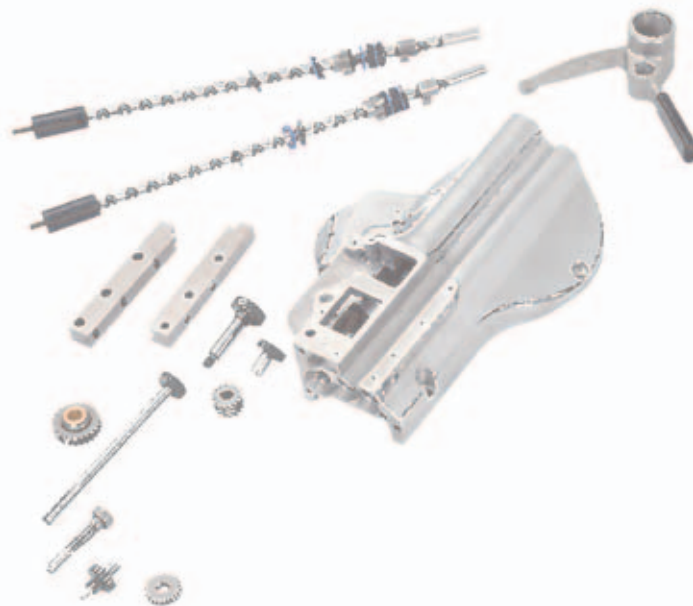

© Great Knives Manufacture Co., Ltd.

The trademark and artworks are the intellectual property which is preserved by GREAT KNIVES MANUFACTURE Co., Ltd. All offense against the copyright will be sued by the owner.

FOR 零件索引

1	58	36270	25	202702	76
1 1/2	58	37469	26	202893	20
02	58	37472	26	204161	20
2	58	37514	26	204351	20
2 1/2	58	37538	26	204367	76
3	58	37919	89	204528	76
04	58	39549	25	204529	77
4	58	39570	25	205255	76
5	58	42305	24	205258	21
06	58	42309	23	205773	76
6	58	47014	10	205890	20
07	58	47409	11	208063	78
7 1/2	58	47410	11	208064	79
09	58	55459	35	208066	78
095	58	56065	86	208215	78
100	43	60507	15	208217	79
113	19	60544	15	208219	79
416	95	68121	36	246061	19
470	11	68184	36	246071	19
471	11	94801	73	257573	35
508	43	94802	73	257574	35
513	95	94902	73	262327	94
525	94	95085	73	272153	87
2626	94	95276	26	277000	20
3543	20	95277	25	277009	20
11442	27	99801	87	300417	27
12482	86	121586	45	301006	62
12701	94	137562	20	301008	63
12800	94	138559	20	301035	62
12801	94	149057	86	301036	63
15710	10	149165	87	306394	21
15722	10	150793	87	308030	63
15730	10	164037	24	330404	27
15740	10	164233	23	350218	35
20271	36	164308	24	350220	35
20491	27	164550	24	410295	24
20493	26	164556	24	412544	24
20496	27	164728	23	412585	24
22195	26	164809	24	412749	24
28964	25	164813	24	414029	35
30421	25	164861	35	414030	36
32667	73	200971	20	540741	36
32672	73	201127	20	540760	35
32914	27	202295	20	755106	27
33353	73	202451	35	755128	27
33545	73	202527	20	784045	19
34598	73	202570	20	784048	19
35285	26	202572	20	1426371	13
35286	27	202573	20	1426970	13
36250	25	202675	76	1429970	13



© Great Knives Manufacture Co., Ltd.

The trademark and artworks are the intellectual property which is preserved by
GREAT KNIVES MANUFACTURE Co., Ltd. All offense against
 the copyright will be sued by the owner.

FOR 零件索引

1430370	13	07-168	18	115-97101 + 118-87106	69
1430770	13	07-169	18	118-45708	18
1431170	13	07-170	18	118-45807	18
1437070	13	07-206	18	118-45906	18
202554E1	76	07-406	19	118-45906	18
7506-1	95	07-505	19	118-46003	16
7506-2	95	07-507	18	118-47407	17
2100167	26	07-558	18	118-47506	17
2108000	73	07-570	19	118-527-0-01	15
2108003	73	07-702	19	118-82107 + 118-87106	70
2108052	73	07-703	19	118-82404 + 118-87106	70
2109000	74	07-707	18	118-82800 + 118-87403	70
2109005	74	08-281	11	118-82909 + 118-87106	70
2109055	74	08-282	11	118-83006 + 118-87304	70
2121111	26	102-11100	32	118-84004 + 118-87403	69
3100512	36	102-11209	32	118-85209	70
3100513	36	102-11605	32	118-85407	69
3101026	26	10-3072-0-024	40	118-86504	69
3101028	27	10-3072-1-024	40	119-49807 + 118-87106	69
3101465	27	105306-101	30	119-49906	69
3101633	26	105307-101	30	11C	02
3109000	75	10C	02	11M	03
3109001	75	10CW	04	11M-SLIDER-HSS	06
3109002	74	10E	02	120-04909	18
3109003	74	10ET	02	121-72805	69
3109020	75	10EW	04	121-73209	69
3109021	75	10EWT	04	121-73308	69
3110037	27	10H	02	123-HSS	08
3110038	26	10HW	04	124-47504	17
3201062	26	10K-HSS	03	12481-11	87
3209000	74	10KM	02	12481-13	87
3209001	74	10KM-SLIDER-HSS	06	12481-15	87
3209002	74	10KMW	04	12481-17	87
3209003	74	10L	03	12481-19	87
3209008	74	10M	03	12481-22	87
3209009	73	10M-SLIDER-HSS	06	12481-9	87
115421010	36	10MW	05	1250004-229B	24
127734001	16	10W	03	1250004-237B	24
127734001	27	10WW	05	1250014-229	24
0246002553	28	11 1/2E	02	1270004-229	24
784045008	19	11 1/2ET	02	129-17-185-3	30
784048001	19	110-1	19	12C	02
020241-01/004 12.7	39	110-40052	32	12L	03
020241-04/005 14	39	112436-0-01	15	131C1-12	94
020241-04/006 16	39	114-09257	32	133C1-11	94
020241-04/007 17.5	39	114-09604	32	133C1-12	94
020241-04/008 19	39	114-HSS	08	133C1-14	94
020241-04/009 22.2	39	115-65900	18	133C1-25	94
020241-04/010 25.4	39	115-66502	17	133-HSS	08
07-124	19	115-90/1-MS-55	09	137-31161	33



© Great Knives Manufacture Co., Ltd.

The trademark and artworks are the intellectual property which is preserved by
GREAT KNIVES MANUFACTURE Co., Ltd. All offense against
 the copyright will be sued by the owner.

<<PARTS LIST

-113-

FOR 零件索引

137-35451	33	15-808	72	205-9101-01A	15
137-35956	34	15-8110-0	72	205-9102-01A	15
137-36103	33	15-8120-0	72	207000-200	22
13E	02	15-8230-0	72	207001-2-00	23
13ET	02	16010(4)	10	207002-2-00	23
140242-0-01	16	16022(4)	10	207003-2-00	22
14088-001	30	16057(4)	10	207004-2-00	23
141509-001	30	16092(6)	10	207006-2-00	22
141512-001	30	16110(6)	10	207015-2-00	21
141513-001	30	16120(8)	10	207016-2-00	21
141541-0-01	31	164-16109	17	207017-2-00	22
141541-0-02	31	164-18709	17	207020-2-00	22
141543-0-01	30	1650004-229	24	207020-2-01	22
143169W	86	166-07301	34	207-113/1	21
144074-0-01	16	166-07400	34	208078-BF	79
144074-300	16	166-07509	34	208090A16F	78
147150LGW	86	166-07608	34	208090-BF	78
14-7900-0	71	166-07707	34	210755(CT)	21
14-7910-0	71	166-07806	34	2109001 + 2109067	75
147-HSS	08	179458-05	62	2109006 + 2109067	74
14-8190-0	71	179459-05	63	2109056 + 2109052	74
148198-0-01	16	2(6)KURIS	10	210K	12
14-8200-0	71	20002 FOR A10	86	21-5602	28
14-8460-0	71	201094B	78	226-55302	33
14-8470-0	71	201121A	21	23420Z-9 1/8H	48
14-8540-0	71	201121ANS	21	23420Z-9 1/8MH	48
14-8560-0	71	201308P	35	23420Z-9 1/8XH	48
14-8580-0	71	202142-0-10	22	24739(4)	10
14-8640-0	71	202143-0-10	22	24741(6)	10
14-8660-0	71	202146-0-10	21	257018B56	77
14-8680-0	71	202194-0-10	35	257018B64	77
148815-0-01	16	202527A	20	257033B56	77
14-8900-0	71	202554E	76	257033B64	77
14-8910-0	71	202618A	76	257053B56	77
149-HSS	08	202854A	78	257053B64	77
14L	03	202932-0-10	22	257207-16F	79
14M	03	203010-0-10	22	257216-16F	79
14W	03	203012-0-10	21	257222-16F	79
152897-0-01	31	203066-0-10	22	257259-16F	79
152901-0-01	31	203069-0-10	21	257262-16F	80
152905-0-01	30	203144-0-10	21	257268-16F	80
152906-0-01	30	203759-0-10	22	257573A	35
152981-0-01	31	203783-0-10	22	2626-S	94
153020-001	31	204161A	20	270-112	22
155193-0-01	15	204360A	76	270-112/1	22
15-7230-0	72	204676-BF	79	270-113	21
15-7270-0	72	204693-0-10	21	270-113/1	21
15-7530-0	71	204693-0-11	21	270-188	35
15-7560-0	71	204730A16F	78	2701P9-113/1	21
15-8070-0	72	204730-BF	79	276B-112	22



© Great Knives Manufacture Co., Ltd.

The trademark and artworks are the intellectual property which is preserved by
GREAT KNIVES MANUFACTURE Co., Ltd. All offense against
the copyright will be sued by the owner.

FOR 零件索引

277-112	22	323-870-212	20	611325N	17
277-113	21	323-870-213	20	6378-112	22
277300-16	78	323-870-214	21	6378-113	21
277302-16	80	323-870-215	20	643C1-41(6 IN)	06
277303-16	80	323-870-218	20	643C1-42(7 IN)	06
277305-16	80	323-873-001	35	643C1-43(8 IN)	06
277323-16	80	323-873-200	35	643C1-45(13 IN)	06
277325-16	80	330N	94	643C1-46(9 IN)	06
277327-16	78	3544A	20	643C1-47(10 IN)	06
277329-16	78	35796B	36	643C1-53(11-1/2 IN)	06
277330-16	78	35796C	36	6-90	19
277337- 25	80	37469-HSS	26	6-91	19
277339-25	80	37472-HSS	27	6-91E	19
277500P30	77	381A	94	6C	02
277500P40	77	39270A	25	6CW	04
277505R30	77	39549J	25	6E	02
277505R40	77	39549N	25	6ET	02
277505R50	77	39570J	25	6EW	04
277513R30	77	39570K	25	6EWT	04
277513R40	77	400/7	95	6H	02
277513R50	77	40-0012-1-045	35	6HW	04
277516R50	76	40-0012-2-045	35	6K-HSS	03
277516R60	76	40-0127-1-000	35	6KM	02
277517R40	77	40-0127-2-000	35	6KM(N)	02
277517R50	77	405-9101-01A	15	6KM-SLIDER-HSS	06
277524T50	76	408-9101-01B	15	6KMW	04
277524T60	76	408-9102-01A	15	6L	03
2777-112	22	42-0012-0-045	35	6M	03
2777-1121	22	428-9101-01B	15	6M-SLIDER-HSS	06
279-112	22	46377(6)	10	6MW	05
279-113/1	21	46378(4)	10	6W	03
290-112	22	48-1125-5-721	23	6WW	05
290-113	21	4E	02	71-90 1"	39
290-113SP	21	4ET	02	71-90 1/2"	39
302807-0-10	22	4H	02	71-90 3/4"	39
302808-0-10	21	4KM(N)	02	71-90 3/8"	39
308026-91	62	4M	03	71-90 5/8"	39
312-870-001	20	4W	03	71-90 7/16"	39
312-870-003	20	501-140/1-MS21	09	71-90 7/8"	39
32-2047-1-001	23	5C	02	71-90 9/16"	39
32-2047-1-002	23	5E	02	71CL 1 1/4"	38
32-2048-1-002	23	5ET	02	71CL 1 1/8"	38
32-2408-1-001	23	5EWT	04	71CL 1 3/8"	38
323-870-005	20	5H	02	71CL 1"	38
323-870-200	20	5HW	04	71CL 1/2"	38
323-870-202	20	5KM(N)	02	71CL 1/4"	38
323-870-203	20	5KM-SLIDER-HSS	06	71CL 11/16"	38
323-870-207	20	5KMW	04	71CL 3/4"	38
323-870-210	20	5M	03	71CL 3/8"	38
323-870-211	20	5W	03	71CL 5/16"	38



© Great Knives Manufacture Co., Ltd.

The trademark and artworks are the intellectual property which is preserved by
GREAT KNIVES MANUFACTURE Co., Ltd. All offense against
the copyright will be sued by the owner.

<<PARTS LIST

-115-

FOR 零件索引

71CL 5/8"	38	9CW	04	B1190-522-YOB 5/16"	69
71CL 7/16"	38	9E	02	B14	85
71CL 7/8"	38	9ET	02	B1528-804-000	33
71CL 9/16"	38	9EW	04	B1528-804-000A	33
7C	02	9EWT	04	B1530-352-000	33
7CW	04	9H	02	B16	85
7E	02	9HW	04	B1609-415-HOB	87
7ET	02	9KM	02	B1613-522-NOO	87
7EW	04	9KMW	04	B1613-522-WOO	87
7EWT	04	9M	03	B1613-555-HOO	87
7H	02	9M-SLIDER-HSS	06	B1657-804-OOT	70
7HW	04	9MW	05	B1657-814-BOE	70
7K-HSS	03	9W	03	B18	85
7KM	02	9WW	05	B20	85
7KMW	04	A10	44	B2001-761-0A0	33
7M	03	A10-NP NO.1	87	B2001-762-0A0	33
7MW	05	A10-NP NO.2	87	B2001-771-0A0	33
7W	03	A10-NP NO.3	87	B2002-761-0A0	34
7WW	05	A10-NP NO.4	87	B2002-771-0A0	33
80C1-101	08	A11	44	B2003-761-000	33
80C1-114	08	A-113	09	B2003-771-000	33
80C1-123	08	A-113(R)	09	B22	85
80C1-133	08	A-113-HSS	09	B24	85
80C1-141	08	A-114	10	B2406-373-0A0	32
80C1-147	08	A-118	95	B2406-761-0A0	32
80C1-149	08	A-121-1	34	B2406-771-0A0	32
80C1-39	08	A30	45	B2408-761-000	33
80C1-59	08	A4	43	B2408-771-000	33
80C1-61	08	A400	42	B2410-373-000	32
8C	02	A4113-102-000	17	B2421-205-0A0	32
8CW	04	A4142-335-000	17	B2421-210-000	32
8E	02	A4145-335-000	17	B2421-210-AA0	32
8ET	02	A450	42	B2421-280-000	32
8EW	04	A70	45	B2421-280-0A0	32
8EWT	04	A70 FEED DOG	87	B2424-210-000	33
8H	02	A75D	42	B2424-210-A00	33
8HW	04	A75U	43	B2424-280-000	32
8K-HSS	03	A9	43	B26	85
8KM	02	ABRASIVE BELTS	69	B28	85
8KM-SLIDER-HSS	06	ACE(Lower)	11	B30	85
8KMW	04	ACE(Upper)	11	B4108-352-000	17
8L	03	AS 1026	11	B4108-352-00B	17
8M	03	AT0204000000	36	B4108-352-00B(L)	17
8M-SLIDER-HSS	06	B	23	B4108-352-00D	18
8MW	05	B1109-415-H00	86	B4111-804-00A	18
8W	03	B1109-555-HOB	86	B4111-804-00C	18
8WW	05	B1190-522-S00 1/8"	69	B4118-804-000	16
91-171853-05	35	B1190-522-T00 3/16"	69	B4118-804-00C	16
990474-0-10	89	B1190-522-U00 1/4"	69	B4121-522-000	28
9C	02	B1190-522-V00 3/8"	69	B4122-352-000	16



© Great Knives Manufacture Co., Ltd.

The trademark and artworks are the intellectual property which is preserved by
GREAT KNIVES MANUFACTURE Co., Ltd. All offense against
the copyright will be sued by the owner.

FOR 零件索引

B4122-352-00A	16	D290	83	FX0228000000	36
B4122-354-00A	16	D3216	83	GRINDING STONE	67
B4122-357-00D	16	D3217	83	GS-181C2-1	96
B4145-530-BOO	68	D390	83	GS-181C2-2	96
B4151-052-A00	28	D4206	84	GS-181C2-5	96
BAND KNIVES	97	D4207	84	H1259	83
BK-10F	36	D569	83	H1262	83
BK213	56	D574	83	H1359	84
BL340	51	D575	84	H26	86
BL342	51	D581	84	H3362	83
BOM-100	10	D582	84	H3363	83
BOM-101(4)	10	DSK-25	16	H4258	83
BOM-80(4)	10	DSK-27	16	H4259	83
BOM-80(6)	10	E14	85	H442	83
BP207	53	E16	85	H445	84
BS333	52	E18	85	H492	83
BS334	52	E1826	81	H494	84
C721 1/4RJ-RE	40	E1827	81	H497	84
CB501	55	E20	86	H500	84
CH141	12	E22	86	H501	84
CH503	55	E24	86	H974	84
CH504	55	E3326	81	HOOG'S 110m/m	09
CP201	52	E3327	81	HOOG'S(R)	09
CP203	51	E3524P	81	K710NA	46
CP204	53	E3826P	81	K712NA	47
CP206	53	E3827P	81	KH301030	62
CT164728	24	E4426P	81	KH301235	62
CT270-112	22	E4427P	81	KH303753	61
CT270-113/1	21	E4826	81	KH303754	61
CT276B-112	23	E4827	81	KM EU 100	96
CT277-112	23	E591B	81	KR-23	23
CT277-113	21	E784	81	KR-23A	23
CT-2777-112	23	E797	81	KR-23C	23
CT-2777-1121	22	E800	81	KR-35	23
CT279-112	22	E805	81	KR-35C	23
CT279-113/1	22	E809	82	KRH-10	10
CT290-112	22	E810	82	KRH-12	10
CT290-113	22	E839	82	KRH-12(4)	10
CT290-113SP	22	E854	81	KRH-15	10
CT302865-0-11	22	E868	82	KRH-20	10
CT39549	25	E870	82	KS-24	36
CT39549J	25	E919	82	KS301148	63
CT39570	25	E920	82	LEATHER-GE	12
CT39570J	25	E934	82	LEATHER-SKS7	12
D100	11	E982	82	LO515	56
D1207	84	E986	82	LO516	56
D1216	84	EB531	57	LO535	57
D2405-555-BA0	32	EG0204000000	36	M688Z	95
D2406-555-B00	34	FA337	48	M700(6)	12
D2406-555-D0H	34	FX0227000000	36	M702	12



© Great Knives Manufacture Co., Ltd.

The trademark and artworks are the intellectual property which is preserved by
GREAT KNIVES MANUFACTURE Co., Ltd. All offense against
the copyright will be sued by the owner.

<<PARTS LIST

-117-

FOR 零件索引

M703(8)	12	R 4M	11	RS-100(8)	09
M740(8)	12	R 4W	13	RS219	54
M741(6)	12	R 5 1/4B	08	RS-232	11
M742	12	R 5 1/4B55	08	RS-50	09
MAS-11012000	17	R 5 1/4E	08	RS-50(7)	09
MAS-11013000	17	R 5 1/4M	11	RS-50(7)-HSS	09
MAS-11016000	17	R 5 1/4M59	11	RS-50-CT	10
MAS-11017000	17	R 5 1/4W#21	13	S02637-001	30
MAT-02203000	61	R 5 1/4W#24	13	S02645-001	31
MAT-02204000	61	R 5E	08	S03627-001	30
MAT-035000AO	60	R 5H	09	S03629-001	31
MAT-03505000	61	R 5KM-HSS	09	S07526-001	31
MAT-03506000	61	R 5M	11	S07527-001	31
MAT-041000AB	60	R 6B	08	S08723-001	65
MAT-041000AO	60	R 6E	08	S08724-001	65
MAT-041000AO-A	60	R 6KM-HSS	09	S08731-001	65
MATC220000AO	60	R 6M	11	S08732-001	65
MF-00A0838	34	R 6W NO.16	13	S08882-001	66
MF-02A0834	34	R 6W NO.18	13	S08883-001	66
MF40A1834	34	R 7 1/2E	08	S08885-001	79
MF40A1835	34	R 7E	08	S08886-001	79
MF40A2835	34	R 7M	11	S10205-001	31
ML-110-1	19	R 7W	13	S10210-001	30
ML-113	19	R 80X40X1.0	12	S10570-001 1/8"	65
MS-55(7)	09	R 8W	13	S10572-001 3/16"	67
PL-Q1-01B	15	R101E08	95	S10573-001 1/4"	67
PUP	13	R101J03	95	S10605-001	67
R 2 1/2H	09	R101W05	95	S123	46
R 2 1/2M	11	R10W	13	S124	47
R 2 1/2W	13	R110-90/3-MS-2	09	S150	95
R 2(R)KURIS	10	R1512	12	S16248-001	31
R 2(8)KURIS	10	R1513	12	S19145-001	65
R 2-5/16B(10)	08	R1514	12	S19146-001	65
R 28X0.3	11	R1515	12	S19154-001	65
R 2KM	09	R4200-HOD-DOO	68	S19155-001	65
R 2KM(7)	09	R4200-JOE-DOO	68	S19162-001	65
R 2KM(7)-HSS	09	R4205-HOD-EAO	68	S19166-001	65
R 2W	13	R4305-HOD-EOO	68	S19169-001	65
R 3 1/2H	09	R4305-JOE-EOO	68	S19185-001	65
R 4 1/4	12	R4508-HOD-DOO	68	S19186-001	65
R 4 1/4-CT	10	R4508-JOE-DOO	68	S19199-001	66
R 4 1/4-CT(2)	10	R4608-JOE-DOO	68	S19202-001	66
R 4 1/4-CT(2-2)	10	R4612-HOF-GOO	68	S19212-001	66
R 4 1/4-SK32	12	R4612-JOD-E01	68	S19217-001	66
R 4 3/4W#22	13	R4612-JOF-DOO	68	S19219-001	66
R 45X0.3	11	R-58	95	S19228-101	66
R 4E	08	RCS-135(8)	09	S19236-001	66
R 4E#141	08	RE-12	09	S19237-001	66
R 4KM	09	RE-12-HSS	09	S19240-001	66
R 4KM(8)	09	RS-100	09	S19244-001	66



© Great Knives Manufacture Co., Ltd.

The trademark and artworks are the intellectual property which is preserved by
GREAT KNIVES MANUFACTURE Co., Ltd. All offense against
the copyright will be sued by the owner.

FOR 零件索引

S19247-001	67	T041-A	60
S20118-001	31	T041-AB	60
S20232-001	65	T042	60
S20234-001	65	T-50	95
S20236-001	65	T-80	95
S20239-101	67	TC 808SP	92
S20241-101	66	TC-100	90
S20245-001	67	TC-230	93
S20579-101	16	TC-230P-GE	93
S20582-001	15	TC-801	90
S20583-001	15	TC-805	91
S20896-101	16	TC-805B	91
S20897-101	16	TC-808S-B	92
S20898-101	16	TC-P220	93
S20899-001	15	TC-P240	93
S25190-001	65	TC-P260	93
S356N REECE 1 1/4"	40	TC-P280	93
S356N REECE 1 3/8"	40	TC-P300	93
S356N REECE 1"	40	TC-RG01Y-GE	92
S356N REECE 1/2"	40	TC-RG02B-GE	92
S356N REECE 1/4"	40	TC-RG03O-GE	92
S356N REECE 1/8"	40	TC-RGMIX-GE	92
S356N REECE 11/16"	40	TC-S230(BLUE)	92
S356N REECE 11/8"	40	TC-S230(MIX)	92
S356N REECE 3/4"	40	TC-S230(ORANGE)	92
S356N REECE 3/8"	40	TC-S230(PURPLE)	92
S356N REECE 5/16"	40	TC-S230(RED)	92
S356N REECE 5/8"	40	TC-S230(TURQUOISE)	92
S356N REECE 7/16"	40	TG-99S	89
S356N REECE 7/8"	40	THEARD-260	30
S356N REECE 9/16"	40	THEARD-755	30
S37723-001	31	WB301	49
S400	42	WB302	49
S450	42	WB307	49
S56370-001	31	WB308	50
S56917-001	30	WB309	50
S60	44	WB313	50
S70	45	X05007001	15
S72L	44	X05007001	27
S75D	42	CLEAN GUN	98
S75U	43		
SH502	54		
SPARE PARTS FOR EASTMAN	100		
SPARE PARTS FOR KM	109		
ST211	54		
SW75D	48		
SW75U	48		
T022	60		
T035	60		
T041	60		



© Great Knives Manufacture Co., Ltd.

The trademark and artworks are the intellectual property which is preserved by GREAT KNIVES MANUFACTURE Co., Ltd. All offense against the copyright will be sued by the owner.